



Issue 1

C.S.U.D.H. ELECTRONIC STUDENT JOURNAL OF
ANTHROPOLOGY



Spring 2011

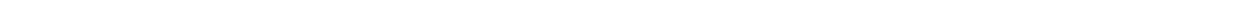

VOLUME 6 (1): SPRING 2011

California State University Dominguez Hills Electronic Student Journal of Anthropology

Editor In Chief

Scott Bigney

Review Staff

Celso Jaquez
Jessica Williams
Maggie Slater
Alex Salazar

©2004 CSU Dominguez Hills Anthropology Club

1000 E Victoria Street, Carson CA 90747

Phone 310.243.3514 • Email CSUDHESJOA@gmail.com

Table of Contents

THEORY CORNER

Essay: Functionalism in Anthropological Theory
By: Julie Wennstrom pp. 1-6

Abstract: Franz Boas, "Methods of Ethnology"
By: Maggie Slater pp. 7

Abstract: Marvin Harris "Anthropology and the Theoretical and Paradigmatic Significance of the Collapse of Soviet and East European Communism"
By: Samantha Glover pp. 8

Abstract: Eleanor Burke Leacock "Women's Status In Egalitarian Society: Implications For Social Evolution"
By: Jessica Williams pp. 9

STUDENT RESEARCH

Chinchorro Culture
By: Kassie Sugimoto pp. 10-22

Reconstructing Ritual Change at Preceramic Asana
By: Dylan Myers pp. 23-33

The Kogi (Kaggaba) of the Sierra Nevada de Santa Marta and the Kotosh Religious Tradition: Ethnographic Analysis of Religious Specialists and Religious Architecture of a Contemporary Indigenous Culture and Comparison to Three Preceramic Central Andean Highland Sites
By: Celso Jaquez pp. 34-59

The Early Formative in Ecuador: The Curious Site of Real Alto
By: Ana Cuellar pp. 60-70

Ecstatic Shamanism or Canonist Religious Ideology?

By: Samantha Glover

pp. 71-83

Wari Plazas: An analysis of Proxemics and the Role of Public Ceremony

By: Audrey Dollar

pp. 84-98

Architecture, Agriculture, and Imperialism

By: Joseph Schaefer

pp. 99-108

The Influence of Inca Statecraft on the Site of Huánuco Pampa

By: Tori Bullock

pp. 109-119

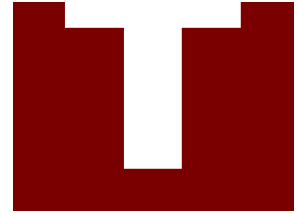

“Functionalism in Anthropological Theory”

By Julie Wennstrom

In the field of Anthropology there are two theoretical approaches used to analyze the stance theorists take on culture. The Idealist approach is the belief that a culture’s core values, beliefs, and ideals are what shape their behavior and consciousness of the world. Idealists argue that the material conditions of society are determined by these core values found in their society. The Materialist approach is the belief that a society’s consciousness and behavior is determined by the material conditions of existence (environment, technology, economy). A Materialist would argue that values and beliefs are constructed based upon these conditions. Materialists look at these conditions of existence to come to law-like generalizations that can be applied to all societies. These two approaches may initially seem like polar opposites, but there is a way to integrate both views into one. This “In-between” approach is not merely a placid stance on anthropological theory, but a valid perspective all on its own. This paper will examine three different articles which will show the Idealist, Materialist, and In-between point of view with respect to functionalism as a common theme between them.

Functionalism is the theory that society operates like an organism, made up of interdependent structures that work together for the survival of the entire societal system. Functionalism has taken two separate perspectives in Anthropological theory – one being the viewpoint of Bronislaw Malinowski and the other of A.R. Radcliffe-Brown. Bronislaw Malinowski’s

position on functionalism was that culture functioned to meet the ever growing needs of the individual in society. On the other end of this theoretical spectrum was A.R. Radcliffe-Brown. His position on functionalism was that society had connected social structures which worked together for the “maintenance and perpetuation of society.” All three articles I will analyze in this paper have their own approaches to functionalism, as defined by Radcliffe-Brown, with different views present.

The article that illustrates the Idealist approach is *Social Anthropology: Past and Present* by Edward Evans-Pritchard. In it, Evans-Pritchard argues that instead of treating anthropology as a natural science we should model it as a social history and study it in the humanities. Evans-Pritchard extensively reviews the different theoretical approaches to anthropology in different time periods. The 18th Century philosophers believed societies were empirical and could be explained by the terms of natural law. He refutes these ideas and claims they were mostly speculations and a priori judgments about primitive societies. He also criticizes the stance taken by 19th Century Victorian Evolutionists, which is that societies are organisms whose development can be explained by general laws that are evident in past ethnographies. He dismisses the theory of diffusionism from the 20th Century and focuses his main attack on functionalism. Evans-Pritchard claims that functionalists assume that if social structures are already in place in society, then they must already serve a function and there is no need to study their history. He believes exactly the opposite and insists that the history of a society needs to be studied to fully understand it. He points out that collective memory of a culture’s past could actually represent a record of their history if there are no previous ethnographies to consult. This history would allow for comparative studies between present and past cultures. This view is completely disregarded by functionalists, who believe knowledge of a culture’s entire history is unnecessary. Evans-Pritchard solidifies his argument by showing the incredible similarities between the work of historians and social anthropologists: 1) translating overt features of other cultures into his/her own culture’s terms; 2) analyzing the latent form of a culture; 3)

comparing his/her analysis of different social structures. His overall case argues for the discipline of social anthropology to study history to arrive at conclusions about different cultures and to stop using functionalism as a theory to explain societies.

The Materialist article I have chosen is *Anthropology and the Theoretical and Paradigmatic Significance of the Collapse of Soviet and East European Communism* by Marvin Harris. Harris' article shows a completely materialistic view on human society with implied functionalism. He comes up with his own tripartite model of culture that labels the juncture between population, society, and culture as a "socio-cultural system". This tripartite model consists of three domains: Infrastructure, Structure, and Superstructure. Harris explains that within each domain lies specific issues. Infrastructure contains the mode of production (technology, work patterns, food acquisition) and reproduction (birth, fertility, mortality). Structure includes the domestic economy and political economy. Superstructure contains religion and cosmology. Harris argues that the Infrastructure domain holds the two aspects that most clearly relate us to nature. Since infrastructure is governed by the laws of nature, it ultimately holds the most control within the socio-cultural system. If innovations, such as technological advancements, take place in the infrastructure they will only be maintained if they improve the modes of production and reproduction. Because the infrastructure holds so much control within the system, it will cause subsequent changes in the structure and superstructure. These changes can either benefit or harm the overall socio-cultural system. Harris coined his theory "cultural materialism".

Harris explains the downfall of the Soviet Union by employing his materialist theory. He asserts that communism failed in the Soviet Union because they neglected the development of their infrastructure. This resulted in horrific living conditions throughout the infrastructure, such as food rationing, heavy pollution, stagnant grain production, and a decline in coal and oil production. These problems caused a halt in the possible introduction of highly technological innovations into the

infrastructure that could have saved the entire socio-cultural system. Harris concludes that the failure of the Soviet Union was due to structural decline in the materialistic conditions of existence.

For an in-between approach I am going to argue that *Ritual and Social Change: A Javanese Example* by Clifford Geertz shows integration between both materialist and idealist theories. In this article Geertz shows that multiple interpretations from different angles are needed to understand a culture and what causes social change. He argues that functionalism needs to take a more dynamic approach in its theory. In his explanation he uses the terms “logico-meaningful” and “causal-functional” to clarify the distinction between the cultural/sociological realm and their characteristic integrations within society. Logico-meaningful (cultural) integration is the meaning and value of social actions. Causal-functional (sociological) integration is the framework of function these social actions have. He asserts that if these two integrations are undistinguished in a society, it will cause social change.

The example Geertz uses is the funeral of a young Javanese boy in a town which has two different political/religious parties. In this culture, religious symbols had become political symbols. When the town religious official came to perform the funeral ritual and noticed the symbol of the opposing party on his house, he refused to take part. The villagers had two conflicting views of death rituals because of their religion and nobody wanted to step-in and help. The conflict between these two religious/political parties was due to the incongruity between logico-meaningful and causal-functional integration in their society. Geertz’s argument is that social and cultural realms should be complimentary to one another in order to work properly. He claims that he was only able to detect the cause of this social conflict because he was aware of the two integrations necessary in society. He could pinpoint the cause of the conflict by pointing out the inequality between the two realms, especially on the subject of religion.

Functionalism resonates throughout all three of these articles I have written about. Evans-Pritchard thoroughly critiques and then rejects the standard theory of functionalism. He stresses that social anthropology needs to explain a culture through examining that particular culture's history, not their current structure. He also claims that anthropology should be studied as a form of social history in the humanities and not in the natural sciences. This viewpoint is completely opposite of Marvin Harris's, which is that society is like an organism with social structures that hold it in place. These structures serve specific functions, but they can also become dysfunctional. He makes no mention of including history into the study of a culture, which was Evans-Pritchard's main argument. Harris also is opposite from Evans-Pritchard in his view on how anthropology should be studied and treated. He believes the infrastructure in a society is so closely related to the natural world that anthropology must be studied as a natural science. Clifford Geertz seems to take a viewpoint that encompasses a little of both these previous theories. He declares that it is symbols, values, and beliefs that ultimately decide human behavior, and he calls these beliefs "local knowledge". However, he also notes the big role that external social structures play in changing those symbols and beliefs. He contends that the cultural and social structures within society must be seen as mutually dependent, yet conceptually separate. Geertz's theory implies that both idealistic and materialistic viewpoints are necessary for understanding the functioning of a culture. He does not believe anthropology should be the study of either natural law or social history in the humanities, but a search for meaning in interpretations of a culture. Geertz embodies the viewpoint that includes both materialist/idealist theories and intertwines them together to produce a new approach in anthropological theory.

In conclusion I must state the theorist with which I concur is Clifford Geertz. I agree with his in-between view and find complete merit in his argument. His theory embodies a melodic mixture of both the idea that society is structured like an organism, yet at the same time influenced

greatly by values and beliefs. Geertz was able to show how beliefs and social structures can work both independently and autonomously in a society. His was able to show conflict due to incongruent integration of social and cultural realms of the society, which confirms his theory. It is this ideology that is going to help anthropologists find meaning and origin in culture, and understand their conflicts as outsiders. This mixture of idealist and materialist views is what I believe anthropological theory should subsume.

Franz Boas “Methods of Ethnology”

Abstract by Maggie Slater

In Boas’ article, “Methods of Ethnology”, he argues the hypotheses of hyper-diffusion and linear evolution is flawed, and lack supportive evidence. He provides an alternative anthropological perspective, cultural holism.

Boas points out that the hypotheses of diffusion and evolution are similar in that ideas start in one spot and spread from there. He asserts that for these theories to be valid, all societies would have to climb a ladder of development in order to reach the ultimate title of “civilization”. For instance, a society can’t reach “civilization” without first developing a written language.

Boas argues against both points, stating that if diffusion was valid, one would have to believe there is no variation and that all things have the same meaning and hold the same value. To support his argument against evolution, one would have only to look at the Egyptian and Inca societies, neither of which had an alphabet but are great “civilizations” in ancient times.

Boas suggests understanding history is to “not only know how things are, but to know how they have come to be”. However, this is not the shared belief of all anthropologists and for that reason Boas asserts that our perception of cultural history is skewed. He also questions how a person is affected by their social environment as well as how that social environment is effected by them, resulting in inevitable change. The result of this process is the introduction of invention and change on the individual level, rather than diffused through group/societal channels.

Marvin Harris “Anthropology and the Theoretical and Paradigmatic Significance of the Collapse of Soviet and East European Communism”

Abstract by Samantha Glover

In “Anthropology and the Theoretical and Paradigmatic Significance of the Collapse of Soviet and East European Communism” Marvin Harris argues that the primacy of infrastructure can adequately explain why communism failed in the Soviet Union and refutes the idea that the fall of communism has tarnished the validity of cultural materialism.

Harris begins his discussion by defining cultural materialism and its integral theory, the primacy of infrastructure. This theory defines behavior within a society as falling into three categories: infrastructure, structure and superstructure. Infrastructure is comprised of the technological, environmental and economic factors which aid in maintaining modes of production and reproduction within a population. Structure refers to the population’s domestic and political economies. Superstructure refers to those behaviors that encompass the intellectual side of human behavior such as music, art and religion. Harris states these three categories of human behavior are indispensable to society with infrastructure as the basis that determines structure and superstructure. In the case of the Soviet Union, Harris argues that the structure of the economy was not able to promote technological innovation. Harris states that the infrastructure in the Soviet Union rejected communism because it was hindering the capabilities of the infrastructure, thus reinforcing the theory of the primacy of infrastructure and cultural materialism.

Harris concludes his article by disassociating himself from the opinion that capitalism is more effective than communism. Harris points out that both capitalism and communism are rife with problems that affect infrastructure, and that infrastructure will determine whether or not capitalism will remain a viable economic system.

Eleanor Burke Leacock “Women’s Status In Egalitarian Society: Implications For Social Evolution”

Abstract by Jessica Williams

Eleanor Burke Leacock argues that the study and analysis of women’s status in egalitarian societies is inseparable from the analysis of social-economic structures. She contends that ethnographies are skewed due to ethnocentric perspectives regarding social-economic concepts of western societies. Critiquing ahistorical approaches, Leacock argues ethnographies are flawed because they held ethnocentric views with the implication that pre-colonial contact societies remained static and were merely incipient forms of nation-states. Leacock insists that ethnographies expressed misconceived perceptions of autonomous gender roles within domestic and public domains among pre-colonial societies. The westernized perspective of the private domestic realm associated with women, is valued less than that of public realm controlled by men, thus deeming the women’s roles inferior to that of men. An ethnocentric male bias led to the reification of male economic contribution as having greater value than that of women. The introduction of capitalism into egalitarian societies, Leacock argues, is linked to the subordination of women’s roles and the devaluation of the work performed as illustrated in the case of the Montagnais-Naskapi. Leacock asserts that the pre contact egalitarian band society of the Montagnais-Naskapi was transformed into competing patriarchal entities conforming to a western form of ideology and means of production. Addressing the flawed ethnographies of band societies, Leacock points out the contradictory findings of Ruth Landes’ ethnography, “Objiwai Women.” Landes’ finding on the role and status of women acknowledges their strength and autonomy, yet at the same time devalues the women’s role by describing their dependence on men. Leacock concludes that the perception of pre-contact women’s contributions in egalitarian societies is skewed by ethnocentric views of gendered roles and statuses which were subsequently altered by the imposition of capitalism.



“Chinchorro Culture”

Kassie Sugimoto

Department of Anthropology

Introduction

The Chinchorro were a group of people who settled along the Atacama coast around 7020BC. The Chinchorro developed complex mortuary practices, including natural and artificial mummification which changed over time. The earliest dated mummy comes from 5050BC, predating all other society’s development of artificial mummification.

Several sites along coastal Chile and southern Peru have been excavated, accounting for a total of 282 mummies while providing insight as to how the Chinchorro lived and why a small, pre-ceramic fishing community would create such complex mortuary practices.

In his book, “Beyond Death”, Bernardo Arriaza analyzes mortuary practices and their connection to the living and spiritual world as expressed by his “Trilogy of Death”. The Trilogy of Death depicts a link between the social and ideological needs of the living and the

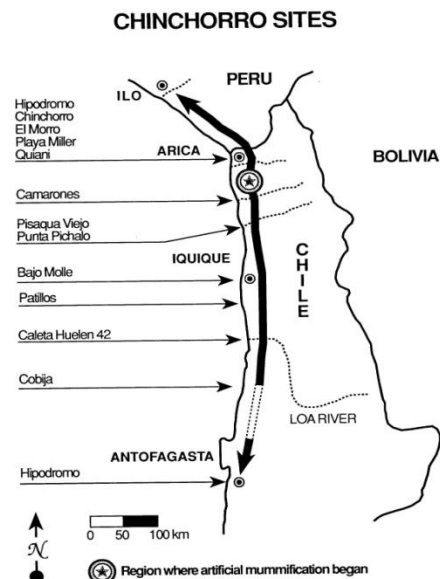
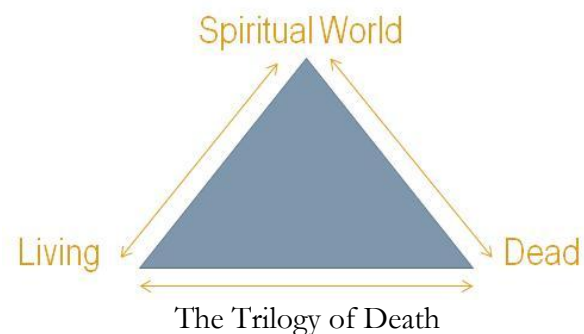

Fig. 2. Map of reported Chinchorro sites along the Pacific coast of Peru and Chile. Solid arrows represent the spread of artificial mummification practices, and the dashed arrow indicates areas of probable spread (drawing: T. Cantrell).

Figure: (Arriaza, Beyond death: The Chinchorro mummies of ancient Chile 1995, 8)

physical and the spiritual needs of the deceased. If mortuary rituals are a means of meeting social, physical and spiritual needs, then changes in ideologies or social needs would explain the changes found in mortuary practices. I believe that as the funerary practices changed over time, there would also be variation in the materials used in burial rituals and burial goods. To establish this correlation, I will compare the different mummy taxonomies with the items used and found in the Chinchorro burials. If my hypothesis is correct, a pattern of cultural change will be established through the variation of material goods and mummification style in each time period. In addition, I will discuss the Chinchorro mortuary practices, how they changed over time based on the analysis of Bernardo Arriaza, the role of the environment, and the possible implication of ancestor veneration.



Background to the Problem

Arriaza arranged a chronology based upon radiocarbon dates from the Chinchorro mummies. Early evidence of Chinchorro culture begins around 7020BC in what Arriaza calls the Founder epoch. (Arriaza 1995, 126-127) During this period, there are no artificial mummification practices. The mummies found from this period were created naturally and did not use any method or tools to preserve the body. Bodies were wrapped in reed mats and camelid furs and buried in extended positions. The dry climate and the natural salts found in the soil were responsible for the preservation of the bodies.

Evidence of the Chinchorro founders does not provide solid evidence to where the initial population originated. Many theories have been formulated to explain how the Chinchorro came to

settle in the Atacama, including migration from other coastal areas and the highlands. The earliest Arica site from 7020BC included lithic points, a technological tool also found in the highlands. Evidence of lithic points substantiates the theory that early Chinchorro migrated from the highlands, or were at least in contact with them. Evidence of the first architectural housing comes from the Founder period, dating to 7020 BC. The earliest architecture consisted of 11 circular huts made from perishable materials. In this period, the material goods found with the architecture imply that the Chinchorro exploited terrestrial and maritime resources in order to support a population estimated to be about 22-44 people.

The Initial period, dating between 5050BC and 4980BC, marks the beginning of artificial mummification. (Arriaza 1995, 127-129) The earliest artificial mummy dates to 5050BC. During this period, lasting from 5050 B.C. until 4980 B.C., only children were artificially mummified and concentration was on the face and trunk of the body. The mummified children from the Initial period are associated with Arriaza's classification of black mummification style.

A formal cemetery from the Initial period indicates the launch of sedentary life for the Chinchorro. Mobile hunter and gathers would practice very different burial rituals than those found from the Initial period. Groups that are continuously changing locations in order to obtain food and resources would have different physical needs for caring of the deceased. The physical issues, such as the process of decay, would not affect a mobile group if they move and are not near the deceased. Typically, mobile groups practiced simple rituals or they burned and abandoned the body. (Arriaza 1995, 36) However, sedentary groups would require more physical preparation to prevent the smell of decay and the visibility of the deceased. In addition to cemeteries and basketry, full time exploitation of maritime resources were developed providing more evidential support that the Chinchorro were sedentary by the Initial period.

In the Classic epoch, the mummification rituals expanded to include both children and adults. Mummies from the Classic Epoch are classified as black mummies and date between 4980BC- 2800BC. Black mummies were prepared by removing all or most of the soft tissue, dismembering the bodies, and putting back together again. White ash paste, sticks, grass, animal hair and twigs were used to reinforce and stuff the body. The legs and spine were bound to sticks as reinforcement. Twigs or reeds were used to reinforce the arms and fasten them to the trunk of the body. Once the mummy was reassembled, white ash was used to reattach the head and mold the features of the face and genitals. Hair was attached and the mummies were painted with black manganese. In some cases, the skin was reattached before the mummy was painted. The black mummies from the Classic epoch are considered the peak of Chinchorro mummification practices due to the level of complexity. Although the use of wigs and complex manipulation of the bodies occurred in both black and

red, the black mummies were fully dismembered whereas the red mummies, categorized in the Transitional period, used slits in the body instead.

Changes in

architectural patterns

reflect associated

transitions in mummification

techniques. Two huts, dating to 4420 B.C. and 4165 B.C. from the Quiani 9 site, revealed changes from circular huts using perishable materials to semicircular huts built with posts and animal skin.

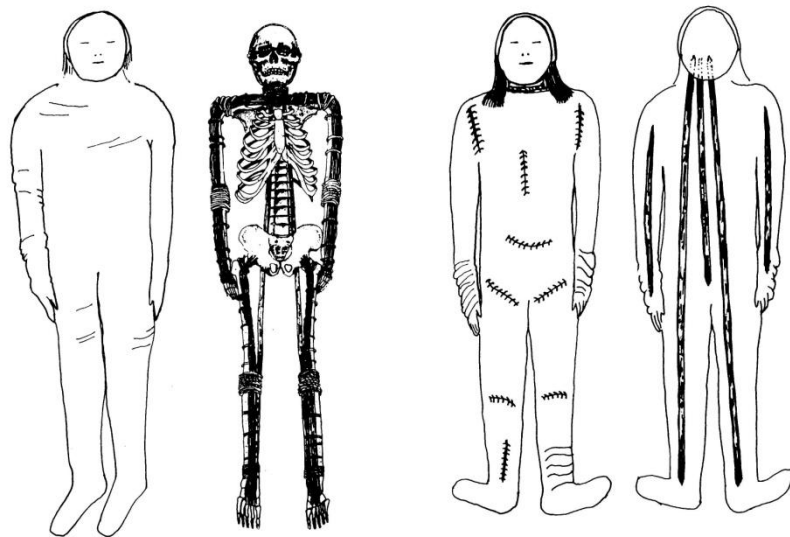

Fig. 35. Black mummy and its inner framework reconstructed (*two left figures*) and a red mummy illustrating its simpler inner structure (*two right figures*) (drawing: R. Rocha).

Figure: (Arriaza, *Beyond death: The Chinchorro mummies of ancient Chile* 1995, 108)

(Arriaza 1995, 35) Although only two huts were found, the midden surrounding the site suggests extended time of occupation of at least a thousand years along with population increase. Other architectural evidence could have been degraded or lost due to contemporary land development. At the end of the Classic period, twenty-two circular architectural structures made of low vertical stone-walls and hard seaweed ash floors indicate more permanent structures. (Arriaza 1995, 35) Other changes in technology involving mummification included throwing sticks and the first evidence of clothing interred with the deceased.

The Transitional Epoch dates from 2620 B.C. until 1720 B.C. and contains a variety of different types of mummies. Red Coated, Mud Coated and Bandaged mummies all indicate a transition period, moving the practice of artificial mummification back into natural mummification. Mummies from the transitional period are still categorized as complex, but were not fully dismembered as was the case with black mummies. Red Mummies were prepared by making incisions to remove the muscles and organs. The body was dried with glowing coals, reinforced with sticks, and then the incisions were sewn back together. The bodies were stuffed with black ashes, white ashes, camelid hair, feathers, grass, animal and bird skin, and soil. The face was molded and covered with manganese, as in



Plate 15. Red mummy head showing helmetlike covering (MIT7C5, subadult) (photo: B. Arriaza).

Figure: Red Mummy (Arriaza, *Beyond death: The Chinchorro mummies of ancient Chile* 1995)

the black mummies, but were painted red. Human hair was added and fixed with manganese,

creating the appearance of a helmet.



Plate 3. Artificially mummified child from Arica (M11)
(photo: B. Arriaza).

Figure: Bandaged Mummy (Arriaza, *Beyond death: The Chinchorro mummies of ancient Chile* 1995)

Three bandaged mummies have been found, but have yet to be radiocarbon dated. The bandaged mummies are associated with the transitional period because at least one adult red mummy was found with a partial bandaged style, appearing around its legs. The three bandaged mummies were all infants. The bandaged style was prepared by removing the skin and reinforcing the body with sticks. The body was then wrapped with strips of human or animal skin and attached with a cord. The face was left

unbandaged and covered with manganese. The mummification of fetuses is called *statuettes* and depicts the emphasis of children within Chinchorro culture. Arriaza defines *statuettes* as artificially mummified fetuses or

infants prepared with small animal bones. These small doll-like mummies were prepared with a large head and no arms or legs. The preparation of the *statuettes* is similar to the red mummies, including the placement of a wig.

Mud coated mummies were prepared with smoke in order to dry the body. Once the body was smoked, it was covered with glue like mud created from sand, clay, and a protienaceous binder, which could have come from blood or glue created from fish or animal remains. The Chinchorro practiced two variations of mud coated mummies; some found fully eviscerated while others were not. At the beginning of the Late epoch, 1720 B.C., complex mummification practices were completely abandoned. The Late Chinchorro's transitioned back to natural mummification. In the beginning of this period, some mummies were found with mud covering the face, while the body was not manipulated. For the following 380 years, bodies in extended positions were laid out in reed mats, allowing for natural desiccation.

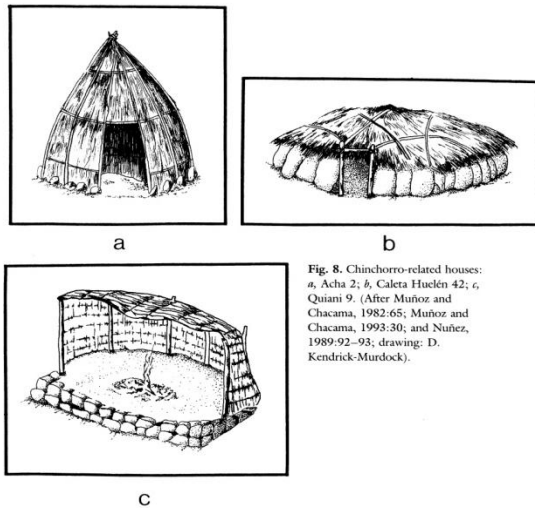

Fig. 8. Chinchorro-related houses: a, Acha 2; b, Caleta Huélen 42; c, Quiari 9. (After Muñoz and Chacama, 1982:65; Muñoz and Chacama, 1993:30; and Núñez, 1989:92-93; drawing: D. Kendrick-Murdoch).

Figure: Chinchorro Housing (Arriaza, Beyond death: The Chinchorro mummies of ancient Chile 1995)

Analysis/Discussion

The environment of the Chinchorro's home territory of Northern Chile and Southern Peru greatly influenced their mortuary rituals and social life. Water temperatures cooled on the coast of Peru and Chile, due to the upwelling of the Peruvian Current at 5000BP, which created a beneficial environment to the Chinchorro mummification traditions. (Rollins, Richardson and Sandweiss 1986)

The temperature drop in the water resulted in significant climate change, creating the dry

environment on the coast necessary for some of the Chinchorro mummification practices. The upwelling of the Peruvian Current during this period created a dependable food source by bringing nutrient rich waters. Analysis of damaged bones in the ear caused by diving, show the Chinchorro maintained a diet of mainly maritime resources, exploiting the benefits provided by the Peruvian Current. Since subsistence mainly relied on maritime resources, the occurrences of El Nino would inflict famine as the Peruvian coastal environment is altered preventing maritime exploitation.

Recent studies have found that arsenic poisoning may have affected the Chinchorro population. Arriaza's findings state that hair strands show continual exposure to arsenic from ground water, rivers, aquatic plants, and seafood. (Arriaza, Amarasiriwardena, et al. 2010) Arsenic will cross the placenta barrier, causing premature birth, stillbirths, neonatal death, and cancer which may explain the emphasis on fetuses, infants, and children mummification. (Ahmad, et al. 2001)

Every culture has different ways of assigning identity to an individual. In the United States, social identity, or recognition of life, immediately follows the birth of the child, if not earlier.

However, there is an array of different ideas on when a person initiates their life and becomes a member of the community. The identity of an individual is a culturally constructed concept that varies between cultures. (Kaufman and Morgan 2005) In many cultures, perceptions of life are largely influenced by the environment, access to resources, and child mortality rates. Nancy Scheper-Hughes reflected on the occurrence of infanticide in Brazil, noting that women with fewer resources to support and care for ill children would withdraw care if they considered the child as already gone, or destined to die. (Scheper-Hughes 1992) Infanticide is often justified within cultures with later social births because recognition of an individual will occur later when chances of survival increase. The separation of social birth from biological birth is used as a coping mechanism, easing the number of lost loved ones by postponing social recognition until a child has better odds of surviving. Initially, I expected to find similar cultural practices imposed trends within the Chinchorro. Since arsenic affects almost every organ, conception must have been very difficult and decreased the number of healthy children born. However, emphasis on fetuses, infants, and child mummification contradicts the belief that social groups with high infant mortality rates will have separate social and physical births. Child mummification is an indication the Chinchorro recognized each fetus, infant, and child as a member of society.

In later periods, the Chinchorro expended time and resources to preserve the bodies of both children and adults, keeping them accessible, burying the mummies in graves after a significant amount of time passed. Although social recognition occurred early, social identity does not explain why the Chinchorro kept their past relatives accessible to them. Ancestor veneration is often connected to the Chinchorro because the mummies were kept accessible to the living. However, the special care they gave children is unique and suggests additional inquiry as to why the Chinchorro would expend so much time on individuals that had little social contribution if they were practicing ancestor veneration. An alternative theory proposed that statuettes and child mummies were used as

medicinal totems, using the spirits of the deceased to guide them through physically challenging times, similar to the use of miniatures within other South American societies. (Arriaza 1995, 114)

Once the mummies were buried, the burial organization seemed to be random, occurring over different time periods, mummification styles, and biological relation. If the Chinchorro practiced ancestor veneration, I would have expected to find evidence of accessibility, maintenance of the mummies, food offerings, and an emphasis on individuals who had contributed to society. The lack of food offerings indicates that mummies were not used for the spiritual needs of the deceased, but possibly for the social needs of the mourners. In “Ancient Mummies in the Andies”, Sonia E. Guillén proposes that mummies were created to increase a particular kinship group to control economical resources. This explanation would account for the emphasis on children, the lack of food offerings, and why the Chinchorro would routinely provide maintenance on the mummies. Once a kinship group gained control, or exceeded the number of mummies needed, they would not need to maintain as many mummies. The deceased may have been believed to be contributors to the living, but not in the sense that ancestor veneration would imply, allowing for children with little or no social contribution to impacting the lives of the living. This theory would explain why the Chinchorro buried several mummies together without any apparent organization.

In order to support my hypothesis, the burial goods in each tier of Arriaza’s chronological system should show variation indicating a shift in social ideologies and social needs. Based on the chronology, there is significant cultural change occurring throughout the Chinchorro culture, including changes in population size as evident from Chinchorro architecture. Material goods found with the mummies also vary. During the Founder Epoch, burial goods consisted of twined reed mats, shell and cactus fishing hooks, fishing lines, and stone knives. This period is associated with the exploitation of both maritime and terrestrial resources. In the Initial Epoch, basketry was added to the existing fishing tool kit. The tools and the introduction of cemetery internment indicate a shift

to a sedentary lifestyle. In the Classic Epoch, atlatl throwing sticks, the use of camelid fibers for fishing lines and skirts developed. During this time, the population increased and more permanent housing was developed. In Transitional Epoch, clothing became recognizable with items such as leather breach cloths for men and grass skirts for women. Head bands and copper ornaments were found with red mummies. The head bands indicate a significant change in social customs, as the trend continued into the Late period. In the Late period, artificial mummification was abandoned, but bodies were still wrapped in reed mats. Intentional annular skull deformations correlate to the use of the head bands from the Transitional period. Hair braiding and the wrapping of the head with yarn developed, indicating another social change in Chinchorro culture. In addition, basketry was further advanced and evidence of tuber cultivation implying the expansion of horticulture subsistence.

Although the mummies and their burial goods provide significant insight into Chinchorro culture, the number of mummies recovered is minimal. The Chinchorro populations are estimated to be low, with only 282 mummies have been found over a long span of time. Many of the mummies and other archeological evidence have been damaged due to contemporary development at the sites, which may explain why only 282 mummies have been excavated. Additional research could further support my hypothesis.

Summary

In summary, the burial practices of the Chinchorro can be analyzed through the chronology developed by Bernardo Arriaza. Each tier of Arriaza's analysis reflects significant changes in mummification rituals and reflects variation in Chinchorro material goods. Cultural changes correlate to the changes found in Arriaza's chronology, indicating changes in population. Environmental factors, such as El Nino occurrences and arsenic poisoning affected the lives of the Chinchorro. Without the Southern Oscillation, maritime resources would not have been available.

The implication of arsenic in the Chinchorro's natural environment provides an explanation as to why infant and child mortality was high. In addition, arsenic provides a possible explanation as to why a high value was placed on children. The mummification of children does not support the idea of ancestor veneration, but does not eliminate the possibility of a connection between the living and the deceased.

Conclusion

In conclusion, Chinchorro burial practices can be analyzed through the trilogy of death. The variation in the burial practices and the material goods reflect change in social needs while creating a need to modify the religious practices to meet the spiritual needs of the deceased. The changes in mummification rituals could have been caused by cultural change with material goods found indicating a gradual increase in population, changes and refinement in subsistence strategy, and cultural novelties. Although the existing evidence supports my hypothesis, additional research could further solidify my findings.

Bibliography

- Ahmad, Akhtar , et al.
2001 "Arsenic in Drinking Water and Pregnancy Outcomes." *Environmental Health Perspectives* 109, no. 6: 629-631.
- Arriaza, Bernardo.
1995 *Beyond death: The Chinchorro mummies of ancient Chile*. Smithsonian Institution Press (Washington)
- Arriaza, Bernardo , et al.
2010 "Exploring chronic arsenic poisoning in pre-Columbian Chilean mummies." *Journal of Archaeological Science*: 1274-1278.
- Arriaza, Bernardo.
1995 "Chinchorro Bioarchaeology: Chronology and Mummy Seriation." *Latin American Antiquity* (Society for American Archaeology) Vol. 6: 35-55.
- Arriaza, Bernardo.
2008 "Chinchorro Culture: Pioneers of the Coast of the Atacama Desert." Edited by Helaine Silverman and William H. Isbell, 45-58. Springer, II.
- Arriaza, Bernardo.
1996 "Preparation of the dead in costal Andean preceramic populations." In *Human mummies: a global survey of their status and the techniques of conservation*, by Konrad Spindler, 135-146. Springer.
- Arriaza, Bernardo. "
2000 Trauma in the Preceramic Coastal Populations of Northern." *American Journal of Physical Anthropology* Volume 112, no. 2: 239–249.
- Aufderheide, Arthur C., Ivan Munoz, and Bernardo Arriaza.
1993 "Seven Chinchorro mummies and the prehistory of northern Chile." *American Journal of Physical Anthropology* Volume 91, no. 2: 189–201.
- Binford, Lewis R.
1971 "Mortuary Practices: Their Study and Their Potential." *Memoirs of the Society for American Archaeology* (Society for American Archaeology): 6-29.
- Boston, Christine Elisabeth.
2009 "Health and morbidity in ancient Chilean populations: Preliminary perspectives using subadult data." *Nexus: The Canadian Student Journal of Anthropology* (The University of Western Ontario, Department of Anthropology) Vol. 21: 17-25.
- Calogero M. Santoro, Vivien G. Standen, Bernardo T. Arriaza and Tom D. Dillehay.
2005 "Archaic Funerary Pattern or Postdepositional Alteration? The Patapatane Burial in the Highlands of South Central Andes." *Latin American Antiquity* (Society for American Archaeology) Vol. 16, no. No. 3: 329-346.
-

- Guillén, Sonia E.
2004 "Artificial Mummies from the Andes." *Collegium anthropological (Croatian Anthropological Society)* VOL 28: 141–157.
- Kaufman, Sharon R. , and Lynn M. Morgan.
2005 "The Anthropology of the Beginnings and Ends of Life." *Annual Review of Anthropology*: 317-341.
- Lau, George F.
2008 "Ancestor Images in the Andes." *The Handbook of South American Archaeology (Springer)*: 1027-1045.
- Moseley, Michael E.
2001 *The Incas and their Ancestors*. New York: Thames & Hudson Inc.
- Rollins, Harold , James Richardson, and Daniel Sandweiss.
1986 "The birth of El Niño: Geoarchaeological evidence and implications." *Geoarchaeology* 1, no. 1: 3-15.
- Scheinsohn, Vivian.
2003 "Hunter-Gatherer Archaeology in South America." *Annual Review of Anthropology (Annual Reviews)* Vol. 32: 339-361.
- Scheper-Hughes, Nancy.
1992 *Death Without Weeping*. Berkley: University of California Press.
- Tainter, Joseph A.
1978 "Mortuary Practices and the Study of Prehistoric Social Systems." *Advances in Archaeological Method and Theory* Vol. 1: 105-141.
- Wise, Karen, Niki R. Clark, and Sloan R. Williams.
1994 "A Late Archaic Period Burial from the South-Central Andean Coast." *Latin American Antiquity (Society for American Archaeology)* Vol. 5, no. No. 3: 212-227.
-

Reconstructing Ritual Change at Preceramic Asana

By Dylan Myers

Anthropology Department

Introduction

On the north shore of the Rio Asana, a tributary of the Rio Osmore, in the Moquegua Department of Peru, there is a preceramic archaeological site with ritual architecture. The elevation of this site is at 3450 m and is in a high sierra environment (Aldenderfer 1989). Seasonal rainfall varies in periodicity and amount but averages 250 mm a year (Aldenderfer 1991). The site has been excavated since 1985 by Mark Aldenderfer who has contributed the bulk of the literature available on Asana.

The size of Asana has been estimated to be between 800 and 1000 m² (Aldenderfer 1988). An exact measurement is impossible due to two historical landslides which have caused significant damage to the area. Landslides occurred most recently in the past 300 years and earlier 4500 years before present (Aldenderfer 1991). Excavations have provided no evidence for agriculture at Asana. Subsistence was based on local exploitation of camelids and huemals and the collection of the edible seeds and chenopod (Aldenderfer 2004).

Occupation at Asana has been dated at 3600 to 9600 years ago. Ceremonial structures are found only in the Qhuna phase of the preceramic period dated as 5000 to 4400 B.P. (Aldenderfer 1991). Given the damaged nature of the site it is difficult to get an estimation of possible population at Asana. Through the Qhuna phase there were four to five structures present per stratum. Based on densities of artifacts recovered, Asana was a wet season camp. Occupied half the year, it would have been a significant center of activity. The residents of Asana likely spent the rest of the year exploiting resources of a nearby puna and camping in caves (Moseley 2001). All other known sites from the

Qhuna phase are either logistical camps or hunting blinds (Aldenderfer 1991).

There are two types of structures at Asana: domestic and ceremonial. Domestic structures are ovular, constructed with brush or animal hide walls, contain small sleeping hearths, and have larger cooking hearths outside them. The ceremonial structures are markedly different. The ceremonial structures may have been shaped like the letter C but it is difficult to say because of the extensive landslide damage to the site (Moseley 2001). The structures have prepared floors made of white clay, and are walled by posts and brush but not roofed. The area of the ceremonial structure grows progressively larger through the Qhuna phase. Beginning at an estimated 22 to 67 m² in size, it grew into an area reaching 132 m² by the end of the phase (Aldenderfer 2004).

The ceremonial structures of each stratum contain a number of curious features. These include: arrangements of unusual stones suggesting telluric based ritual, altars both within and outside of the boundaries of the ceremonial structure, and miniature artifacts interpreted as ritual representations of objects observable by the preceramic inhabitants of Asana. Aldenderfer has found these practices to be similar to the religious rituals of the Aymara people of southern Peru and Bolivia (Aldenderfer 1991). Aldenderfer does not suggest that Asana was an Aymara site, only that it may contain some proto-Aymaran features.

Aymara religion also features telluric ritual aspects, the use of shrines, and the use of miniatures in ritual activity. Based on comparisons of the material remains at Asana and the ritual practice of the Aymara it may be possible to tease out an understanding of the practices at preceramic Asana. If a comparison of features of preceramic foragers can be made with contemporary Aymara agriculturalists then it would be necessary to understand which of the three ritual features of the ceremonial structures at Asana offer the most intrinsic insight to preceramic ritual practice.

Background to Problem

The levels corresponding the Qhuna phase in Aldenderfer's dig are V, VI, VIIb, VIII, IXa, IXb-1, IXb-2 and IXc (Fig. 1) (Aldenderfer 1991). The telluric, shrine, and miniature ritual features are found only in levels VIII through IXc. The ritual features do not all appear contemporaneously through the Qhuna phase. The telluric features only appear in level VIII, the most recent. Miniature features appear in levels IXa and IXb-1 only. Hearths and basins which were used as shrines to burn offerings are found in all levels with ritual activity.

The telluric features of Asana are platforms and circles made from clay and stones. In every level the platform is made out of soil, clay, and angular rocks. The platform is topped by a pyramidal stone split perpendicular on its axis. The surface of the split stone sparkles when exposed to sunlight. On the platform, below the pyramidal stone, is a depression lined by smaller samples of the stone that scintillate in sunlight. The stones used are of local origin but seem to have been specifically chosen for their aesthetic quality. A second platform may have stood on the eastern portion of the site but this has been damaged by the landslides. Fifty small ovals built of clay and small stones were constructed on and around the platforms. The ovals range from 18 to 65 cm in length and average of 35 cm. The ovals are shallow, only three centimeters deep. Many of the ovals contain red or gray stones with the same brilliant mineral inclusions as the platform stones. These sparkling stones are found in the center of the ovals or on the south and east walls.

The Aymara also use stones for ritual purposes (Aldenderfer 1991). A type of cairn called *apachetas* have built by the Aymara over centuries (Tschopik 1951). The cairns are situated at the crossroads in desert wastes and treacherous mountain passes. Passerby's will add a small stone to the pile along with a small token which could be anything from a small amount of coca to broken gear (Aldenderfer 1991). The Aymara believe that this offering will both invigorate the traveler and keep them from harm on the road. Boulders and rock outcroppings are thought to be capable of possessing spirits. One of the best known of these is "Father Atoja". Father Atoja is a large boulder

which has been worked to resemble a human face, around which, offerings are placed. Offerings of camelid bones are not burned inside altars, like Father Atoja, but in surface hearths and basins surrounding the shrine in a 20m radius.

The second ritual feature shared by the inhabitants of Asana and the Aymara is the use of miniatures. In levels IXa and IXb miniature projectile points were found (Fig. 2) (Aldenderfer 1991). The points are of extremely fine craftsmanship and show none of the wear expected from being hafted or used. The points are made either of non-local raw materials or high quality local materials. Because the material used was subject to scarcity it can be reasonably assumed that these points were valuable. There is no evidence that the miniature points were crafted on site as no corresponding lithic debris have been found in domestic middens. Also found was a single, small, stone carving, broken, and of indistinct representation. Aldenderfer interprets the shape as a bird. These miniature stone items were located in hearths but were not burned.

A second type of miniature found in levels IXa and IXb were represented by twig holes in the prepared clay floors of the ceremonial structure. The spacing of the holes is extremely similar to the post holes of domestic residences at Asana. In two of the miniature huts on the IXa floor there was a single smooth river rock placed in the center of the miniature post holes.

Aldenderfer found the parallel of the Asana miniatures in an Aymara festival (Aldenderfer 1991). The Alasita festival is held annually but on different days in different Aymara communities. The Alasita celebrates the god of good luck “E'eq'o” who is represented as carrying dozens of miniature versions of Aymara material culture including food, clothing, and money. The Aymara purchase miniature goods to display next to a figurine of E'eq'o so that they might one day have the good fortune to obtain the miniaturized goods in real life.

The Aymara make use of an alter ritual called a mesa. Mesas may be held in either preexisting altars or an expedient shrine, created just for the occasion. Mesas are performed by magicians and are always performed facing east. Mesas may be held by a magician and apprentice-

helper in private but it is far more common for the ritual to be performed in public (Tschopik 1951). Offerings to be burned during the mesas include a lump of shaved llama fat, flowers, coca, tobacco, and miniature banners (Aldenderfer 1991).

At Asana, basins and hearths have been dug into the prepared white clay floors of the ceremonial structure and show charcoal remains. The hearths range in depth from one to three centimeters and have been simply scooped out of the soil matrix and not built up. The hearths are usually oval but do not appear to follow a formal design. Floor basins also appear at Asana. The basins are differentiated from hearths by their size and construction. The basins are built in two types: one set ranging from 24 cm to 1 m and the other set from 1.5 to 3 m. The basins range in depth from 8 to 17 cm. Some of the hearths and basins appear to only have been used once while others show sign of repetitive use. The basins and hearths appear both inside and outside the walled area of the ceremonial structure only in levels IXa and IXb. In all other levels they are only found outside the boundaries of the prepared floors. Crushed and burnt bone shards are found in both the hearths and basins but in a far more limited number than they are found in domestic hearths or middens. Because of their location in the ceremonial structure and the probability of their specialized use, Aldenderfer suggests that they were used as shrines to burn offerings (Aldenderfer 1991).

The similarities between materials found at Asana and Aymara ritual are intriguing but ultimately can offer no direct parallels. However, through comparison and examination of the ritual features in context with the site certain features appear to be more enlightening about ritual at Asana than others. The only features that are present throughout the entire Qhuna phase are the basins and surface hearths. While telluric features and miniatures may be interesting features corresponding to fascinating religious practices, they cannot speak for the site of Asana in the way that the ever present shrines and altars, as the basins and hearths are understood to be, can and do. That the basins and hearths were sometimes used repeatedly, while others sometimes only once, is very

reminiscent of the Aymara mesas. This similarity is the strongest correlation between what went on at Asana and the religious practices of the Aymara.

Analysis

The shrines and altars, present all through the Qhuna phase, are only found inside and outside the ceremonial structure in levels IXa and IXb. They are only found inside the ceremonial space in level VIII when the telluric features first appear. Although the ceremonial structure has always been bounded, the post holes demarcating the walls become very regular at level VIII. The demarcation implies that there was a separation of ritual activity between inside and outside the ceremonial structures. The presence of walls and distinction of religious function is also indicative of limited access.

Although hidden from view, what went on in the ritual spaces would have been impossible to have been kept a mystery. An examination of the soundscape of Asana shows a great deal of overlap between domestic and religious structures (Moore 2005). The curved lines represent the distance that a regular speaking voice may be heard radiating from each of the houses (Fig. 3). If separation and privacy from the outside was paramount in ritual at Asana, low whispers must have been used, creating an intimate experience for those present (Moore 1996). Likewise any nonverbal communication would only be able to be perceived by those physically present behind the walls. Aldenderfer posits that “The closed nature of the structure suggests that a limited number of individuals witnessed events transpiring inside, and the presence of the platform suggests a formalization of ritual activity. I have interpreted these data as reflecting an attempt to control ritual practice and content” (Aldenderfer 2004). If this is so, then the inside-outside dichotomy of ritual action at Asana may also represent a split between a controlled, formalized practice on one hand and a popular and observable form of ritual action on the other.

The progression of the ceremonial space from being bounded (but visible) to walled off, and

the restriction of shrines and altars to the inside of the ceremonial space at level VIII suggests that ritual activity was more and more controlled and exclusionary as the Qhuna progressed (Aldenderfer 2004). Limited access after a period of openness suggests the existence of some type of hierarchy, either religious or social, resulting from some outside stress (Aldenderfer 1993). Low regional population density and the stability of chernopod (a plant similar to beets) foraging makes stress over periods of low food yields unlikely (Aldenderfer 2004). If the preceramic inhabitants of Asana were engaged with reciprocal exchange with groups in lower or higher ecological zones who were able to increase production over time, then it may have become increasingly difficult for Asanans to keep up their side of the bargain. Unless domesticated, it is very hard to increase chernopod productivity because of high harvesting costs (Aldenderfer 2004). Change in ritual activity could have been a way to deal with this stress.

If the ritual leaders of Asana hoped to assuage the hypothetical stress through redefinition and intensification of ritual practice then their results must have met with middling success (Aldenderfer 1991). Public ritual in the form of offerings in the basins and hearths persisted until the end of the Qhuna phase.

The period following the Qhuna, the Awati, marked the end for ceremonial structures at Asana. Additionally, subsistence patterns shifted to a reliance on camelid pastoralism and the size of domestic structures shrank from their earlier Qhuna phase sizes (Aldenderfer 2004). In the Awati there is no evidence for persistent leadership, ritual based or otherwise. However, it is ultimately unknown if the changes between the Qhuna and Awati phases were a result of a change in activity at Asana or an entirely new population inhabiting the area. Additionally, more research is necessary to discover if the change at Asana was regional or site specific (Aldenderfer 1991).

Summary

The three ritual features of Asana all have correlations to contemporary Aymara ritual

practice. Of the three ritual objects, miniatures, telluric features, and shrines, only two are relevant for understanding ritual practice at Asana as a whole (Fig. 4). Telluric platforms and shrines are better clues than miniatures to ritual change. The movement of shrines from both inside and outside the ceremonial structures to strictly outside, and the introduction of stone platforms, in conjunction with the exclusionary walls implies that ritual at Asana shifted radically from an egalitarian system to one tightly controlled. The persistence of outside shrines even in level VIII suggests that ritual at Asana either could not be completely controlled or that the uses of shrines were a popular form of ritual distinct from what went on in the ceremonial structures.

Conclusion

As the longest lasting ceremonial feature, the basin and hearth shrines presumably have the greatest ritual importance. Over a brief period of only 250 years, the people of Asana developed ritual architecture, experienced several shifts in ritual practice, and then abandoned their ceremonial structures all together (Aldenderfer 1991). The shrines at Asana offer an unrivaled window into ritual practice and ritual change in the prehistoric Andes.

Figure 2

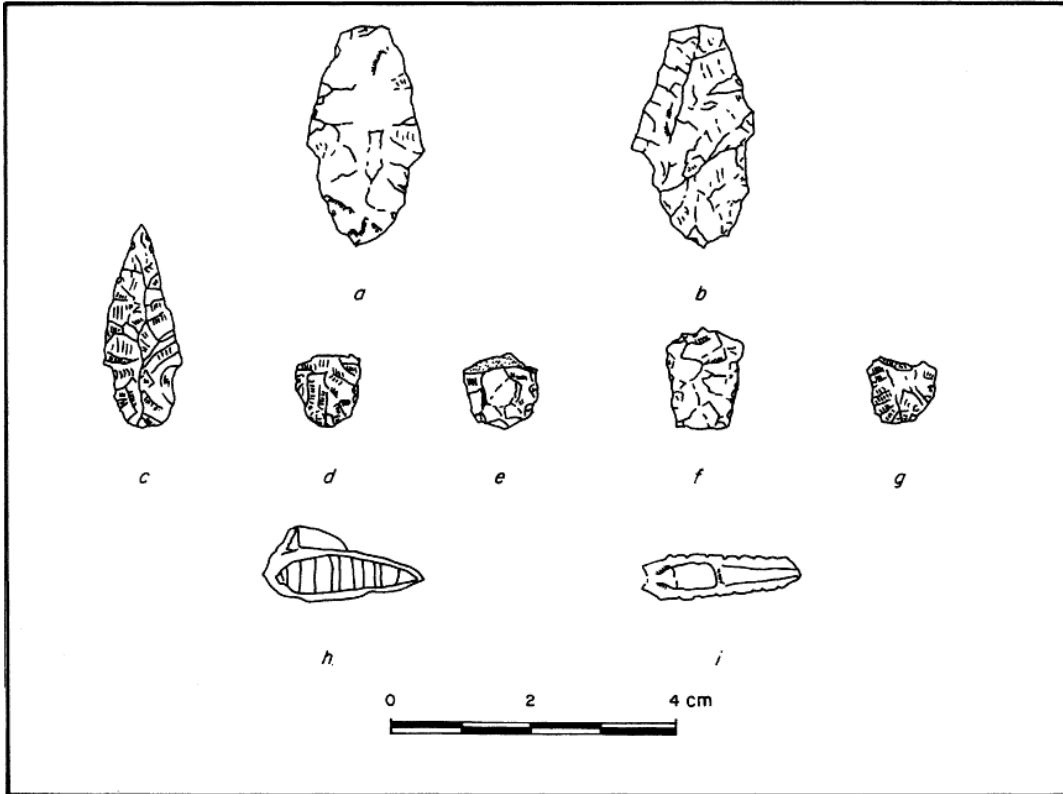
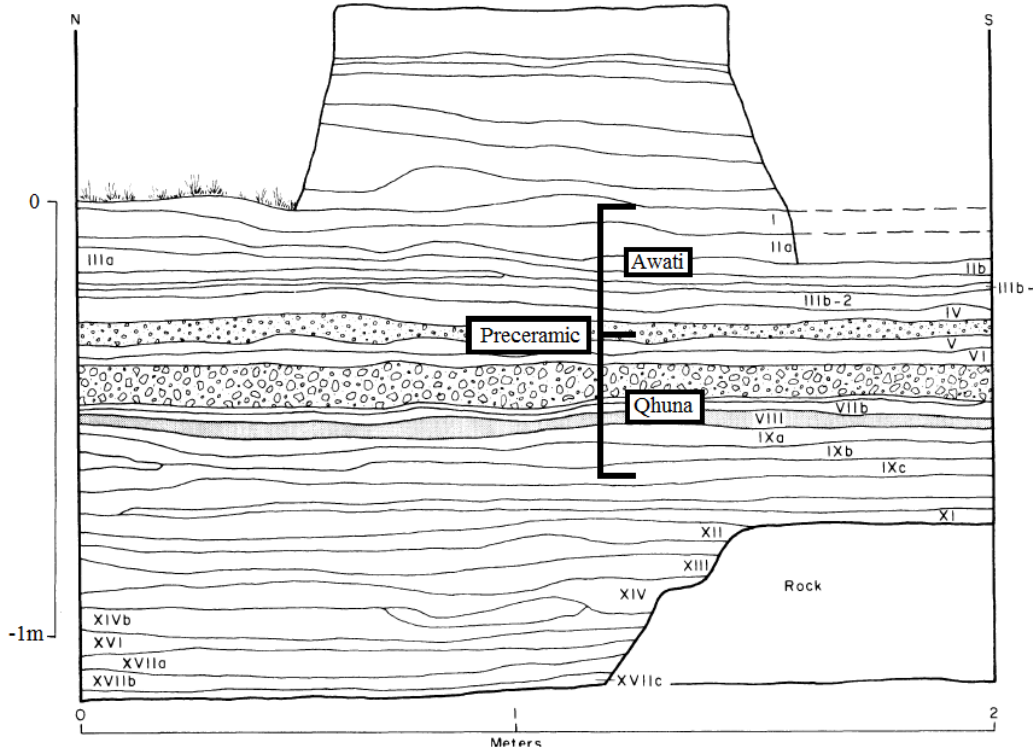

Figure 1



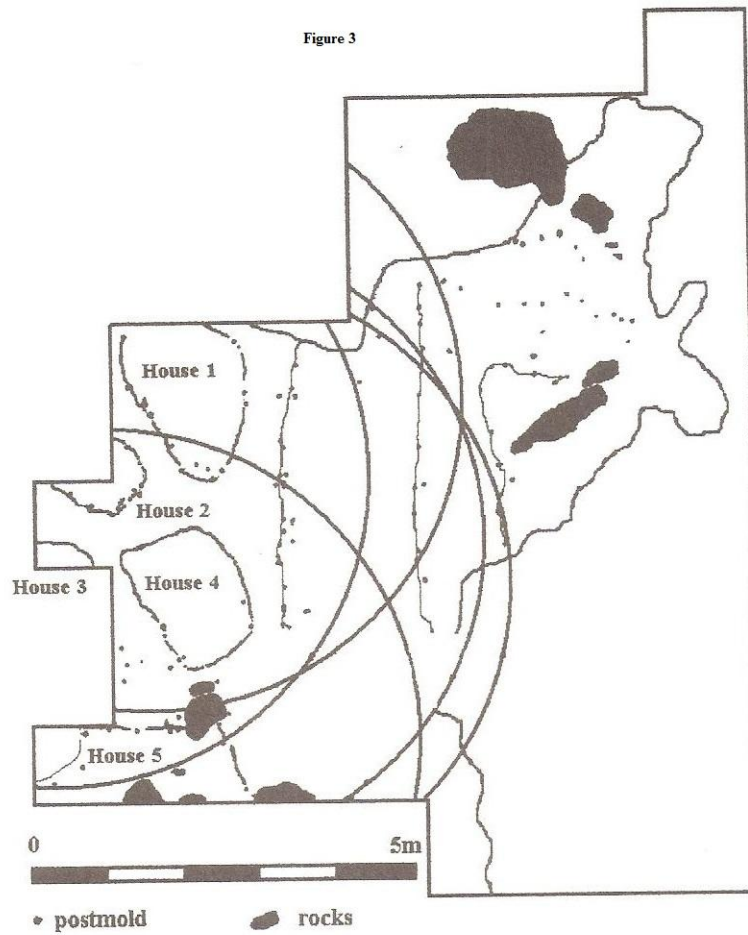

Figure 4

	IXc-1	IXb-2	IXb-1	IXa	VIII
Platforms					X
Stone circles/ovals					X
Clay-surfaced basins	?	X	X	X	X
Surface hearths	X	X	X	X	X
Miniature circles/ovals			X	X	
Miniatures			X	X	

Bibliography

- Aldenderfer, Mark. "The Archaic Period in the South-Central Andes." *Journal of World Prehistory*, 3 (2) (1989): 117 – 158.
- Aldenderfer, Mark. "Continuity and Change in Ceremonial Structures at Late Preceramic Asana, Southern Peru." *Latin American Antiquity*, 2 (3) (1991): 227 – 258.
- Aldenderfer, Mark. "Middle Archaic Period Domestic Architecture from Southern Peru." *Science*, 241 (4874) (1988): 1828 – 1830.
- Aldenderfer, Mark. "Preludes to Power in the Highland Late Preceramic Period." *Preludes to Power in the Highland Late Preceramic Period*, 14 (1) (2004): 13 – 35.
- Aldenderfer, Mark. "Ritual, Hierarchy, and Change in Foraging Societies." *Journal of Anthropological Archaeology*, 12 (1) (1993): 1 – 40.
- Bell, Catherine. *Ritual Theory, Ritual Practice*. New York, NY: Oxford University Press. 1992.
- Moore, Jerry D. "The Archaeology of Plazas and the Proxemics of Ritual: Three Andean Traditions." *American Anthropologist*, 98 (4) (1996): 789 – 902.
- Moore, Jerry D. *Cultural Landscapes in the Ancient Andes*. Gainesville, FL: University Press of Florida. 2005.
- Moseley, Michael E. *The Incas and their Ancestors: The Archaeology of Peru Revised Edition*. New York, NY: Thames and Hudson. 2001.
- Rappaport, Roy A. *Ritual and Religion in the Making of Humanity*. Cambridge, UK: Cambridge University Press. 1999.
- Tschopik, Harry. "The Aymara of Chucuito, Peru." *Anthropological Papers of the American Museum of Natural History*, 44 (2) (1951): 137 – 308.
-

“The Kogi (Kaggaba) of the Sierra Nevada de Santa Marta and the Kotosh Religious Tradition: Ethnographic Analysis of Religious Specialists and Religious Architecture of a Contemporary Indigenous Culture and Comparison to Three Preceramic Central Andean Highland Sites”

By Celso Jaquez

Anthropology Department

Introduction

The goal of this paper was to conduct a cross-cultural comparative analysis of how religious authority of the Kogi Indians of the Sierra Nevada de Santa Marta Mountains of northern Columbia is manifested in their ceremonial temple architecture, and how this manifestation compares to temple structures among the Central Andean Preceramic Kotosh Religious Tradition sites of Huaricoto, La Galgada, and Kotosh. In the initial stages of this investigation I learned that the term Kogi refers to the language spoken, and Kaggaba is the name the indigenous people of the Sierra Nevada de Santa Marta call themselves. I will be using Kaggaba in place Kogi for the remainder of this paper.

As will be evident, the goal took a somewhat unexpected turn once I determined that being able to conduct an effective analysis of Kogi temple architecture required that I first develop insight into the social, political, cosmological, and religious structure of this incredibly dynamic and complex group. I would have to develop an understanding of what Colin Renfrew refers to as the “archaeology of mind” (Renfrew 1994). Renfrew makes the point that to do this; researchers would have to first give considerable thought regarding our “archaeological approach to religion.” He states that the major obstacle to arriving at this understanding is the absence of an adequate methodology that would allow researchers to conduct such analysis (1994). Nevertheless, by

carefully examining the social and ideological framework of a living culture I will attempt to extrapolate an accurate picture of another separated by time (over 2,000 years) and space (over 1,000 miles), thus avoiding the pitfalls warned of by Renfrew.

Methodology

I will focus essentially on secondary source documentation when considering the archaeological evidence of the Kotosh sites. These include records and analysis of excavations written by Andean scholars including Jerry Moore (2005, 1996), Richard Burger and Lucy Salazar-Burger (1985), Michael Moseley (2001), Sheila and Thomas Pozorski (2008), Jonathan Haas and Winifred Creamer (2004), to name a few.

For the examination of the Kaggaba, I felt compelled to seek out the most detailed and comprehensive sources due to my total lack of previous exposure to this culture. To accomplish this, I looked into the ethnographic work of Augusto Oyuela-Caycedo (2008, 2001, 1996) and the late scholar, Gerardo Reichel-Dolmatoff (1982, 1976), two of the most learned researchers in the study of this Highland Columbia group.

Additionally I have included analysis of the archaeology of religion and shamanic religious practice as part of my resource methodology. Jane Monnig Atkinson (1992) and Colin Renfrew (1994) added insight into contemporary shamanic practice and the archaeological approach to interpretation of religious ceremonial architecture.

Background of the Problem

Colin Renfrew warns of the danger that we may “carry into the inquiry [of the archaeology of religion] our own culturally-encapsulated, and therefore perhaps stereotyped, view of what religion is” (Renfrew 1994). This “danger” had not occurred to me when I began my research, but is

now become an important guide as I attempt to draw critical analysis of the two culture groups who are the subject of this paper.

Starting out, the most pressing problem in attempting to draw comparative analysis between Late Pre-Ceramic religious expression and that of a living culture group centers around the issue of the aforementioned separation of time and space. Next, while we have a fair amount of evidence in the form of excavated architectural structures from Huaricoto, Kotosh, and La Galgada, attempting to draw comparison of these structures to those of the Kaggaba first carries with it the temptation to draw a simple correlation between known similarities in the way of habitat, population size, and settlement pattern between Kotosh Tradition sites and those of contemporary SNSM (Sierra Nevada de Santa Marta) inhabitants. In doing so, one must resist making assumptions that, as Colin Renfrew so accurately states, "...to talk of the archaeology of religion [of the ancient past] presupposes that religious experience was available then as now" (Renfrew 1994). Simply overlaying Kaggaba cosmological and religious thought and architectural design I therefore initially considered an exercise in comparing apples and oranges.

Adding to the problem as I began undertaking this project was the overriding issue of my complete lack of understanding of who the Kaggaba Indians are, how they interacted with each other, and more importantly, with the supernatural. Before I could move toward attempting an accurate comparison, I had to first complete a cursory form of ethnography. The down side to this was its redirection from the original intent of this paper.

Research Hypothesis

While both the inhabitants Kotosh Religious Tradition sites and the Kaggaba of the Sierra Nevada de Santa Marta exploited very similar environmental niches, it is unlikely that the similarities extend beyond this point. Sociopolitical and religious conventions separated by over 2,000 years, and the effects of post colonial contact would render any further similarities extremely doubtful.

Analysis and Discussion

Kotosh Religious Tradition sites

Kotosh Religious Tradition sites derived their designation as a result, in part, to their locality in the central Peruvian Andes to the site of Kotosh (Fig 1). Among the shared characteristics are; detached, one room enclosed sanctuaries designed to accommodate small, private congregations, with a focused ritual attention on offerings burnt in a central hearth (Moseley 2001). One theory about the use of the hearths is that they were utilized as part of a “heating ritual” along the lines of

North American sweatlodge ceremonies (Pozorski & Pozorski 2008). It is believed that the congregations engaging in ritual within these intimate spaces were probably kin based, though there can be virtually no certainty on this particular point.



Figure 1: Kotosh Religious Tradition Sites

As Jonathon Haas and Winifred Creamer point out, despite the use of the term Kotosh Religious Tradition, “it is important to recognize that there are no indications that the site of Kotosh was either the earliest to manifest this ceremonial complex, nor was that there was a pan-regional center or “capital” of this religious tradition” (Hass & Creamer 2004). They go on to argue that the commonality of the “widespread distribution of a common architectural feature” in the central Andes was a strong indicator

that shared religious beliefs were being integrated in a “complex ideological system of communication and interaction” (2004). As with the question of whether sanctuary chamber use was kin based, the exact nature of communication and interaction is not clearly defined, though Hass and Creamer speculate that it could possibly be related to the emergence of a similar system of religious practice developing on the coast about the same time. Sheila and Thomas Pozorski also posit that the possible “ultimate origin of what crystallized into the Kotosh Religious Tradition” may have had its origins along the coast, and point to examples of ventilated hearth structures the site of Caral, located on the Central Peruvian coast, as evidence supporting this theory (Pozorski & Pozorski 2008) (fig 2).



Figure 2 Caral Ritual Chamber w/ Ventilated Heart

The structural characteristics of KRT (Kotosh Religious Tradition) ceremonial chambers are noted as: 1) relatively small, self contained units measuring about 1-2m across, 2) are usually square, containing niches in the room walls, 3) and have a central hearth which is ventilated by one or more horizontal shaft or flues. While these general characteristics are found throughout

the KRT sites, there can be great variation in both size and configurations of the ritual chambers from site to site (Pozorski & Pozorski 2008).

Huaricoto

Huaricoto is located at an elevation of about 2750 m. Very early ceremonial structures excavated here are smaller by comparison to those found at either Kotosh or La Galgada. Jerry

Moore notes that the earliest hearths excavated as dating to $4210 \text{ BP} \pm 120$ to $3970 \text{ BP} \pm 110$ (Moore 1996). The hearths, while similar in design, lacked any signs of having enclosed wall rooms. (figs 3-4) At a depth of almost 3m deep, they are not considered associated with the large-scale construction at the site (Haas & Creamer 2004). There were few large ritual chambers built, though many KRT style sanctuaries have been identified dating to about 2260 BC, with evidence of use extending another 2,000 years into the Chavin Horizon (Moseley 2001).

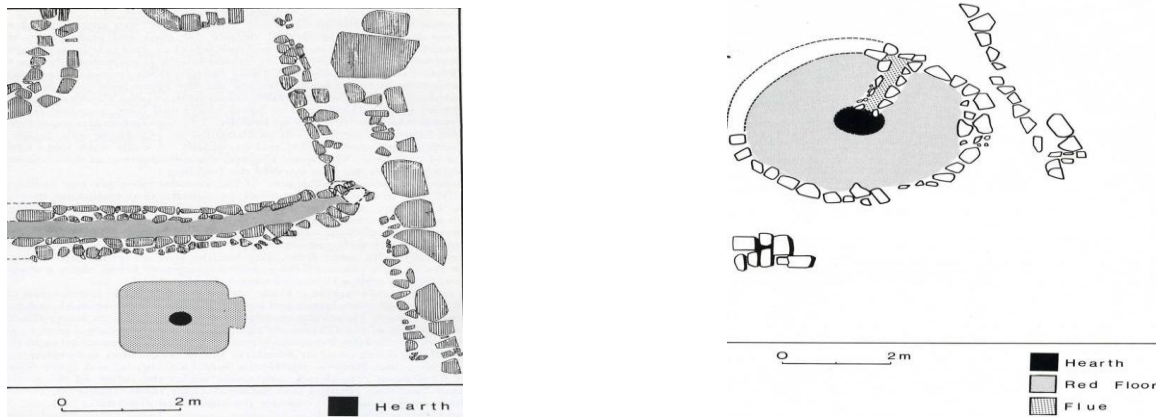

Figures 3-4. Huaricoto hearth chambers

Moseley describes the construction of the Huaricoto sanctuaries being “relatively flimsy and variable” made primarily of wattle and daub. He believes intent behind their architectural design



was to “create an enclosed cubicle with a single entry that could be sealed.” It was noted that the floors of the chambers were carefully plastered by those responsible for maintenance keeping the floors in a constant state of good repair, including regular replastering of the central hearth (2001).

Ritual internment of old chambers in favor of newer constructions is evident from the

Figure 5. Ritual Internment of Ceremonial Chamber

discovery of what Moore describes as “thirteen superimposed, deeply buried ritual structures,

dating between 2200 BC and 200 BC” (Moore 1996) (fig 5). Additionally, the absence of “domestic features or debris” within these structures indicate they served a non-secular purpose. Richard Burger and Lucy Burger-Salazar believe that at Huaricoto purity of space was directly linked to the concept of cleanliness and that dangerous consequences might have been associated with non-compliance to this ideal (Burger & Burger-Salazar 1985). Burger and Burger-Salazar point out that the small size of the ritual chamber and the associated labor required for construction and maintenance suggest a social structure of “relatively small social units organized in a cargo-like system, not by large corporate labor units.” They conclude that this “more flexible social order” was responsible for the construction of the ritual hearths at Huaricoto, which denote this site features as being quite different from features excavated at La Galgada (1985).

It is not until the Huaricoto Phase of construction that we see the introduction of a sub-floor flue within a chamber containing a circular wall. The inclusion of the sub-floor flue is a hallmark feature of the Kotosh Religious Tradition ritual ceremonial constructions (1985). Despite this, Burger and Burger-Salazar point out that the importance in noting significant differences in scale, design, and chronology. Specifically, the fact that KRT features such as large stone ritual chambers, sub-floor flues, and constructions exceeding 5m in diameter appear at Huaricoto, La Galgada, and Kotosh, though doing so at the later two during the Preceramic, while not doing so at Huaricoto until the Initial Period (1985).

La Galgada

The site of La Galgada is located at an elevation of 1,100 m in the valley of the Tablachaca River. As noted by Hass and Creamer its location is situated in the transition zone between the

central highlands and the Pacific coast (Haas & Creamer 2004). The most prominent architectural features of the ceremonial complex include two platforms of unequal size, both containing KRT



Figure 6. Main Ritual Mound at La Galgada

style chambers. These chambers were roughly 3-5 m in diameter (Moore 1996). Dating has placed construction between 2200 BC and 1200 BC. The main complex mound is about 40 m in diameter, though the exact height of the mound is unknown due to it having been constructed on 13 m of

fill. (Fig 6) Atop the main mound are found temple rooms similar in shape and size to those found at Kotosh. They are roughly quadrangular with rounded corners, thick walls 2-4 m in height, containing wall niches, a central hearth, ventilator, and an elevated bench which runs along the inside wall. Haas and Creamer note a walled circular plaza situated directly in front of the mound (2004). Moseley adds that the ceremonial chambers were entered from the east with a horizontal ventilator shaft running under the door providing air to feed a central hearth (Moseley 2001).

Moseley also points out that unlike Huaricoto, ritual chambers were **not** filled in when temple interment was done. Instead, large rock slabs subsequently covered them. The chambers were left hollow, with a new chamber built above with a vertical shaft included connecting the two. The old chamber was then converted into a mausoleum, with each one used to house two or more adult bodies. He adds, “Females were well represented as were unusually fancy accompaniments

including ornate textiles, baskets, seashell jewelry, and bone ornaments inlaid with stone.” Moseley also noted that access to the venerated dead was maintained for generations, and speculates that ritual interaction with the ancestral dead was left in the hands of ritual specialists (2004). (Figs 7-8)

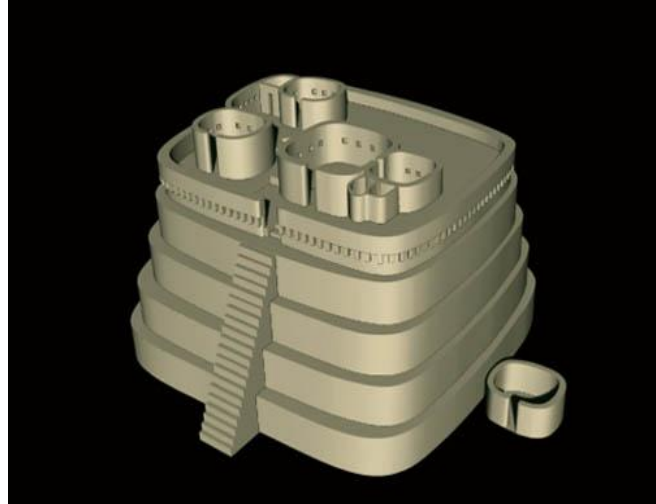

Figures 7-8. La Galgada moundtop ritual chambers

Between 1700 and 1200 BC Kotosh style chambers were replaced by new ritual space which featured: very large single mound-top sanctuary, unroofed and rectangular rooms with an over-sized fire basin. Unlike Kotosh type chambers, these could hold up to 50 people or more involved in larger burnt offering rituals, with the final stage constructions featured U-shaped configurations on the summit (2004).

Moore feels that these changes in architecture have “implications for broader social changes, as public architecture shifted from ritual chambers to a moundtop U-shaped structure” (Moore 1996). He sees the “scattered arrangement” of the ritual chambers at the site as possibly reflecting an integrated social order organized at the suprafamilial level, with greater coordination and integration taking place later as the shift to ritual practice in the U-shaped structures atop the mounds developed (1996).

Kotosh

Kotosh is located at an elevation of about 1800 m, near the modern town of Huánuco. The site consists of two mounds that over the course of more than a thousand years of construction and rebuilding reached a height of between 6.5 and 8 m (Haas & Creamer 2004). This twin mound construction has led Moseley to speculate whether these possibly reflect moiety social organization, though this is at least at present, only conjecture without supporting evidence (Moseley 2001).

Construction beginning about 3,000 BC consisted of temple structures measuring 3-6 m across and having thick walls reaching 2m in height or more. Among the shared characteristics, these ritual chambers had; “finely plastered floors and walls, wall niches, a central sunken hearth, a ventilator,

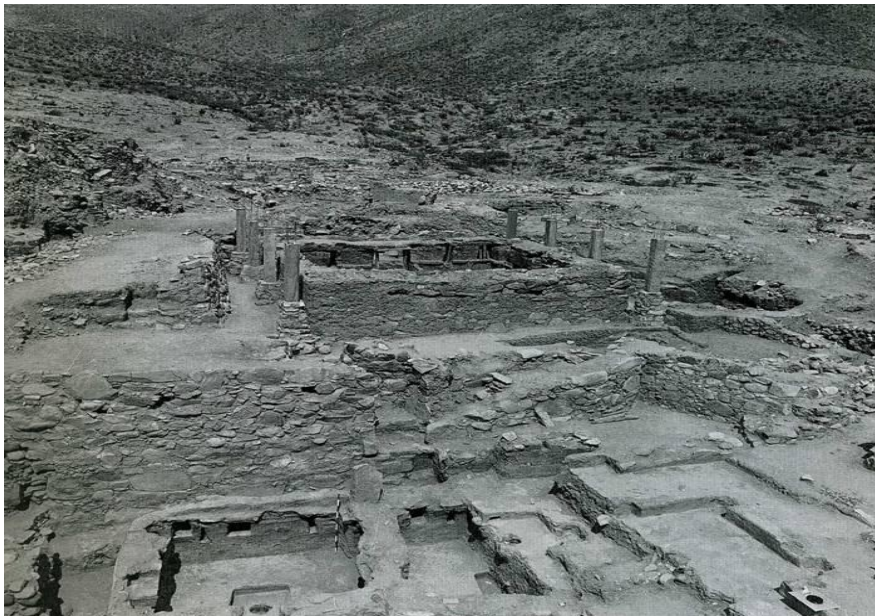

Figure 9. Main site mound at Kotosh

and a bench area for seating” (2004). As was the case at Huaricoto, ritual internment of temple structures is also evident at Kotosh. Haas and Creamer have estimated that there may have been as many as 100 temples erected at the site during the initial phase

construction.

The main feature at the site is a mound, which measures almost 100m in diameter, and reached a height of 8m. Moseley notes that trench excavations “exposed ten superimposed

constructions. Like the mounds at La Galgada, the Kotosh platforms contained “wide terraces upon whose summits were a series of many chambers” (2004). (Fig 9)

The most elaborate of all KRT constructions was located on the middle terrace of the largest platform. Measuring about 9m square it featured thick, plastered walls adorned with rows of ornamental niches. Opposite the entrance to the chamber was an oversized niche flanked by a smaller niche on each side. Below each of these two smaller niches are clay friezes depicting a pair of



human hands crossed at the wrists which researchers dubbed the *Temple of the Crossed Hands* (Figs 10-12).

Figure 10. Kotosh – Temple of the Crossed Hands as it appears today

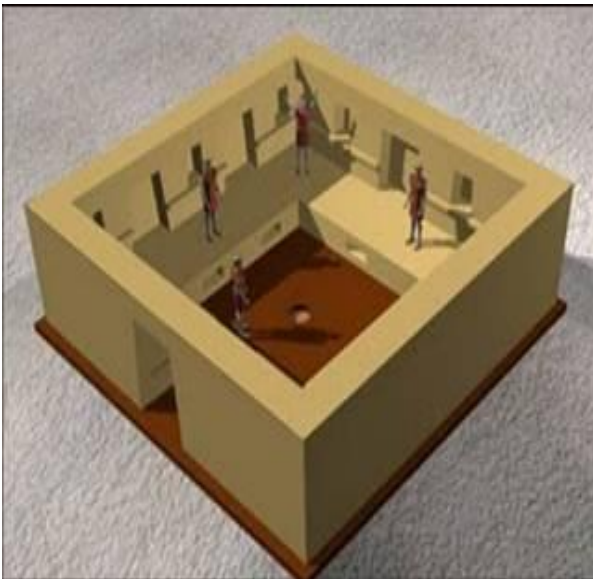

Figure 11. Artist's rendering of temple

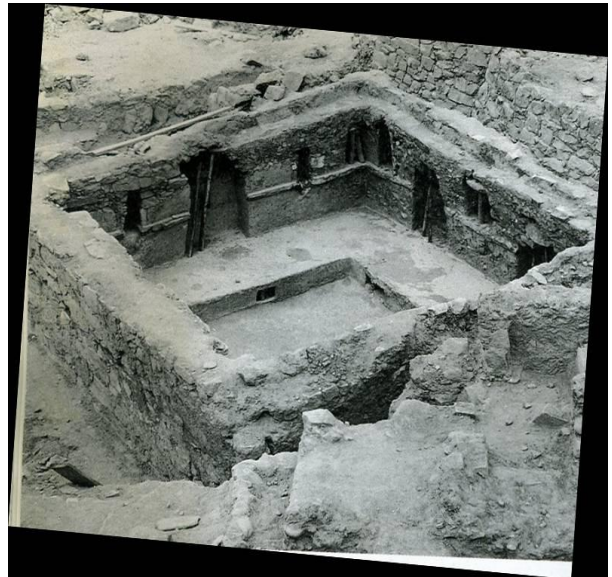

Figure 12. Same P.O.V. of actual temple

The difference in the size of the hands and arms has led some researchers to speculate as to whether these features reflect a male/female component to ritual observance within the temple

(Hass and Creamer 2004). (Fig 13) The temple was filled during an elevating construction phase with a new structure also containing ornamental niches, but no friezes. This was given the name the

Temple of the Niches.

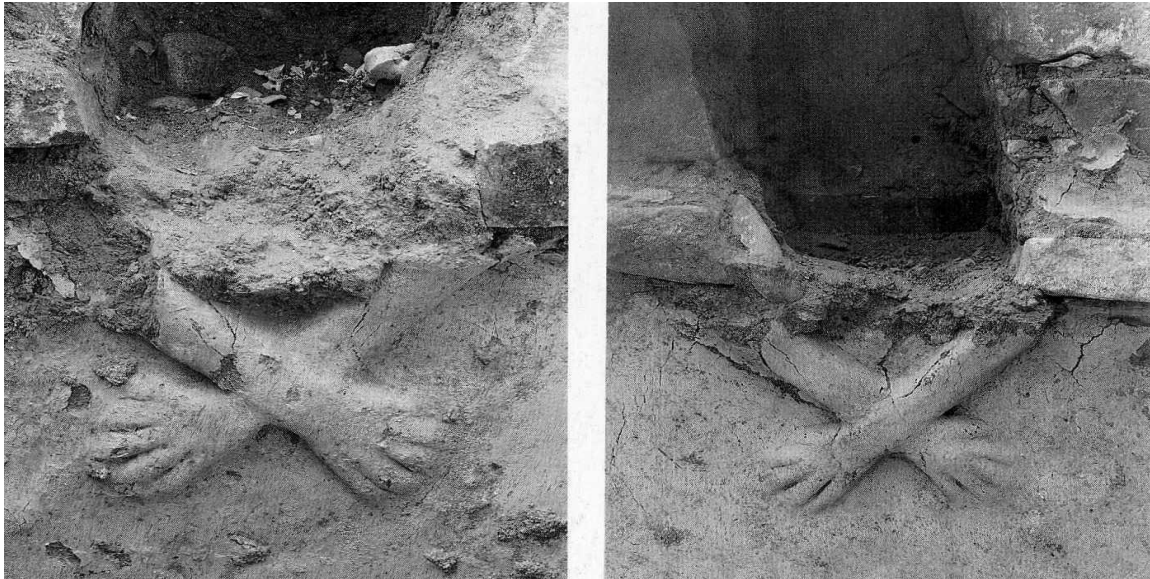

Figure 13 close up detail of the crossed hands frieze

Sociopolitical and Religious Implications

Several scholars have speculated that the very presence of “a regional religious tradition,” along with the complexity of construction of temples and mounds at Kotosh and La Galgada may indicate the early stages of centralized political and religious organization in the central highlands. The absence of residential structures coupled with the concentration of ritual temples, as well as the amount of labor necessary for their construction are strong indicators of centralized organization (Haas & Creamer 2004). Moore theorizes that the architectural developments at La Galgada may in fact reflect a change from egalitarian society to one in which “social distinctions” emerge (Moore 1996).

The point of centralized authority as it applies to the religious realm has some interesting implications when considering the nature of KRT ritual structures. The closed, intimate spaces,

which all these ceremonial chambers contain, would normally indicate the presence and practice of ecstatic shamanism. Ritual would be held with practitioners displaying their skills as shamans in close proximity of their attendants. Such intimate interaction would lead one to assume, as Jane Atkinson points out, shamans were utilizing this space to legitimize their authority (Atkinson 1994). However, as Hass and Creamer point out, the “likelihood that irrigation agriculture was practiced at La Galgada” it is easy to surmise that local religious leaders would have controlled the economic resources, labor, and distribution as part of their consolidation of power and authority (2004). Was this an anomalous sociopolitical feature of the KRT? What can we learn by conducting analysis of a contemporary Andean culture that shares a relatively common environmental habitat and long historic link to the pre-Columbian past? These were the questions I hope could be answered by my investigation into the Kaggaba Indians of Columbia’s Sierra Nevada de Santa Marta Mountains.

The Kaggaba Indians of Columbia’s Sierra Nevada de Santa Marta Mountains



The Kaggaba Indians live along the northern face of the pyramidal mountain of the Sierra Nevada de Santa Marta. Despite the harsh, barren terrain, and poor soils the Kaggaba have been able to preserve their traditional way of life for over 500 years (Reichel-Dolmatoff 1976). (Fig 14) They claim to be descendants of the ancient Tairona culture who occupied this environmental zone from at least 500 BC (Oyuela-Caycedo 2008). Gerardo Reichel-Dolmatoff advanced the theory that Kaggaba culture is the result of what he

refers to as a “continual transformation” which he sees beginning with the Tairona, and has

maintained a constant state of change through the ethnographic present. The Kaggaba remained a part of the cultural transformation, as opposed to being a “society encapsulated in time” (Reichel-Dolmatoff 1976).

Sociopolitical and Religious Structure

Augusto Oyuela-Caycedo describes the sociopolitical structure of the Kaggaba as being a “theocratic chiefdom, in which religion is the source of power which is concentrated under the authority of the house priest” (Oyuela-Caycedo 1998). He states that at one time civil authority was

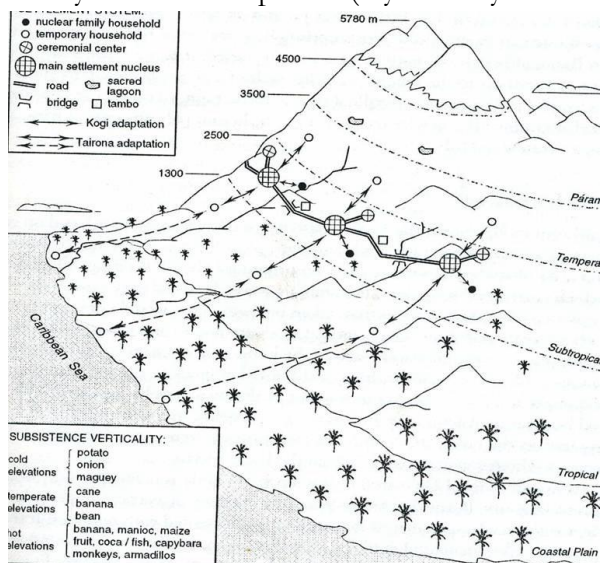

Figure 14. Kaggaba Environmental Zone

under the control of the *Makú*, a headman whose ascribed position has all but disappeared as an institution of power in the Sierra Nevada de Santa Marta (SNSM). The Kaggaba are organized around lineages, with alliances between houses serving to provide communal support. Houses are consolidated into either a town or a group of allied settlements which are formed around a chief who is recognized as

the head of the highest ranking house with alliances created by marriage (1998).

Houses, which are the foundation of lineages, have sacred temples with a priest who presides as religious leader, but also as chief or head of the house. As pointed out by Oyuela-Caycedo, “the Kaggaba are a society of temples, priests, sacred hamlets, sacred spaces, complex cosmology, and seasonal festivities of rituals where religious recitation and esoteric knowledge are the bases of power” (1998). An important element of Kaggaba religious structure as relates to the discussion of the Kotosh Religious Tradition secular authority is the fact that the Kaggaba priest’s knowledge serves as the mechanism by which he legitimizes his control over such secular duties as agricultural

practices, the cooperative labor of a house, the locations of dwellings, as well as such expected religious duties such as overseeing rites of passage and ritual confession. Oyuela-Caycedo is quick to mention that despite this high level of undisputed authority, the Catholic Church and the government still maintain a fair degree of influence.

The priest, known as the *Máma*, is the transmitter of knowledge, and is the only person who is

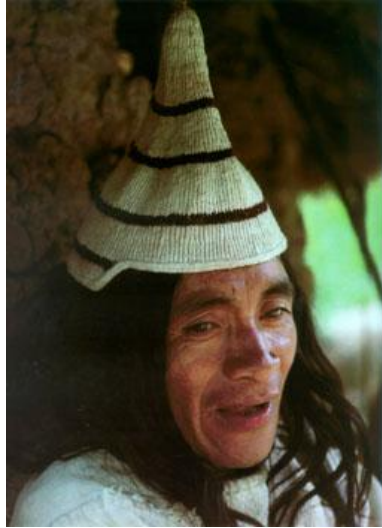

Figure 15. Kaggaba Priest

allowed to learn the “Mother Laws,” the ultimate sacred canons.

(Fig 15)

Knowledge is the primary factor in determining the prestige and/or rank of priest within his house, as well as in relation to priests of other houses (1998). In other words, a hierarchy exists with the priest class of the Kaggaba, and is predicated on the level of accumulated knowledge in such areas as botany, astronomy,

mortuary practices, cosmology as well as dance and music.

Kaggaba Religion and Cosmology

Kaggaba religion is closely related to their concepts of universal structure and function, with personal behavior and interactions with nature serving to maintain universal balance, which extends not only to the Kaggaba communities, but also to the entire planet. In this way, the Kaggaba see themselves as “grandchildren” of the Mother-Goddess’ four sacred sons, and as such are

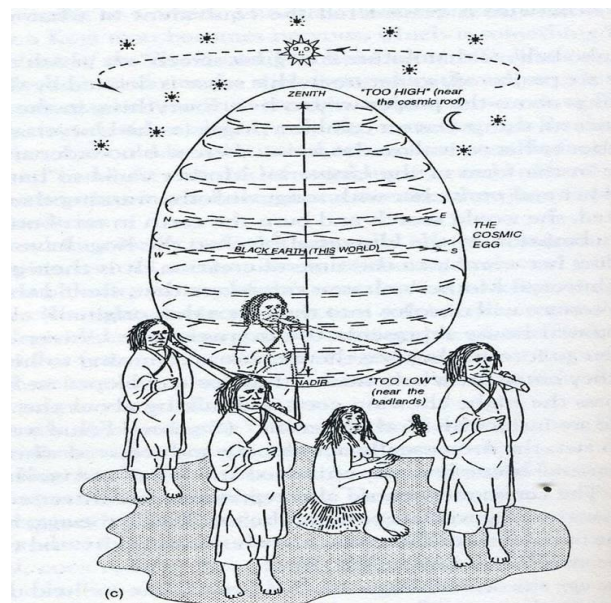

Figure 16. Kaggaba conceptualization of the “Cosmic Universal Egg”

obliged to serve as stewards as well as guardians of Mother Earth (Reichel-Dolmatoff 1976).

The Kaggaba view the universe as a Cosmic Egg, “encompassed between the seven points of reference: North, South, East, West, Zenith, Nadir, and Center; stratified into nine horizontal layers, the nine worlds (the fifth of which is ours).” The Cosmic Egg is conceived as the womb of the Mother-Goddess, with the land conceived as a huge female body that nourishes and protects all her earthly children (1976). (Fig 16)

A full examination of Kaggaba cosmology would constitute an entire separate project, so I will close this section by saying that the Kaggaba see the world today as being in a state of extreme stress brought about by the abuse, neglect and poisoning of the environment. They see it as their responsibility to heal our Mother, and in doing so returning the universe to its proper balance (1976).

Priests

The priest, known as the ***Máma***, is the transmitter of knowledge, and is the only person who is allowed to learn the “Mother Laws,” the ultimate sacred canons. Knowledge is the primary factor in determining the prestige and/or rank of priest within his house, as well as in relation to priests of other houses (1998). In other words, a hierarchy exists with the priest class of the Kaggaba, and is predicated on the level of accumulated knowledge in such areas as botany, astronomy, mortuary practices, cosmology as well as dance and music.

The local priest is the arbiter of local disputes. As with most elements of Kaggaba society, hierarchy factors into this process. The degree of seriousness of the dispute will decide who in the priestly hierarchy will settle the dispute. While the priest has the right to punish, transgressions committed by a priest would require a higher-ranking priest. Punishment can be simple social ostracism, or as severe as death (1998).

For the Kaggaba, religious knowledge can only be transmitted through specific channels of ascribed training for the priesthood. Oyuela-Caycedo notes that it is the priest's sister's son who is the preferred candidate for these training programs (Oyuela-Caycedo 1998). The process of apprenticeship will sometimes begin as early as age nine, although Reichel-Dolmatoff states that ideally a future priest would be separated from his mother at birth and would begin a life-long process of training in all areas of knowledge deemed essential for the proper maintenance of universal balance (Reichel-Dolmatoff 1976). Refusal to give up a child is considered not an option, with civil authorities occasionally getting involved to take the child by force. This is extremely rare given the Kaggaba's deep understanding of their communal responsibility in the universal order. It is

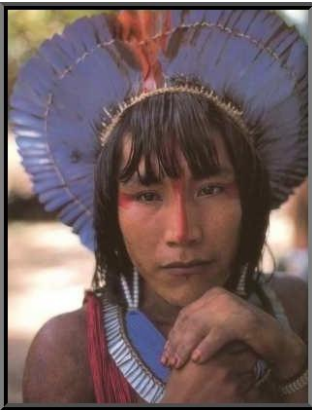

also the custom for the family of the apprentice child to receive compensation in form of periodic food rations, or the providing of field labor (1976).

Novice Kaggaba Mama

The novice will spend most of their waking hours in the men's ceremonial house. (Fig 17) During their long years of training they are restricted to live in a state of nocturnal existence. They are forbidden from leaving the ceremonial house during the day. Once their training is complete, usually at the end of their third 9-year cycle of training, they assume roles as priests of their house lineage (1976).

As described by Reichel-Dolmatoff, life in the ceremonial house is

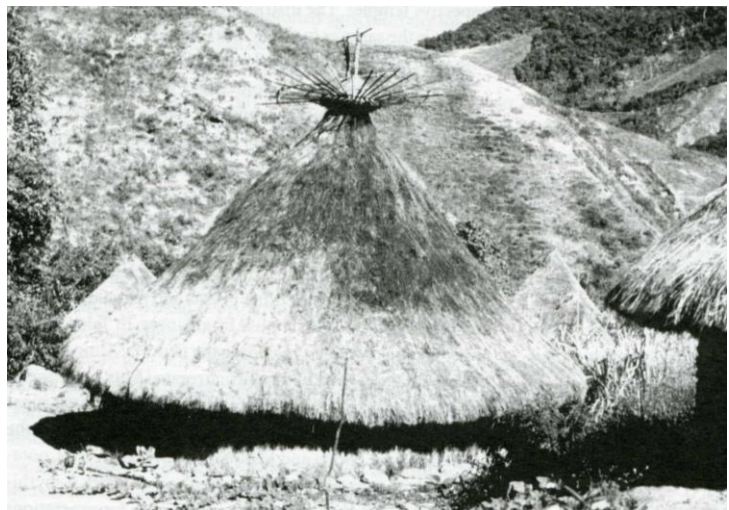

Figure 17. Kaggaba Ceremonial House

almost entirely devoted to the acquisition and exchange of knowledge. Priests devote their lives in pursuit of expertise in the areas of:

1. Cosmogony, cosmology, mythology
2. Mythical social origins, social structure, and organization
3. Natural history: geography, geology, meteorology, botany, zoology, astronomy, biology
4. Linguistics, ceremonial language, rhetoric
5. Sensory deprivations; abstinence from food, sleep, and sex
6. Ritual; dancing and singing
7. Curing of diseases
8. Interpretations of signs and symbols, dreams, and animal behavior
9. Sensitivity to auditory, visual, and other hallucinations

The grand scope of the body of knowledge is what is believed to be essential for allowing Kaggaba priests to function effectively in their role as protectors and nurturers of Mother Earth. It is also, in part, the reason they refer to themselves as “elder brothers” to all of mankind (1976).

Priests compete against in other in a test of each other’s religious knowledge. This serves as the mechanism for determining ranking. While usually restricted from participating, commoners are occasionally allowed to participate (Oyuela-Caycedo 1998).

In terms of personal wealth and possessions, Kaggaba priests, while holding positions of great prestige, power and authority display no greater level of wealth than any other member of the community. In fact, for the Kaggaba the accumulation of personal wealth is greatly discouraged by way of social pressure, “with low prestige given to those who accumulate goods” (1998).

I have only touched briefly on the subject of cosmology and priesthood, certainly not doing either justice. Both deserve examination in the way of complete individual research papers. The goal here was to provide an idea of the two cultural features which most impact the design and function of the ceremonial and religious architecture of the Kaggaba.

Countryside Temples, Religious Hamlets and Ceremonial Villages

Kaggaba ceremonial and religious architecture demonstrates the same level of complexity, as their cosmology and training for priesthood. Size, location, and function all have variants, which are affected by a stratified hierarchy, tied to lineage, and one's association with a ranking priest (Oyuela-Caycedo 1998).



Figure 18. Contemporary Kaggaba Village (note Ceremonial House located upper left of village)

Villages

contain as few as 10 or as many as several dozen round huts.

These dwellings are all about 2-3m in diameter and are constructed of wattle and daub, and cone shaped. (Fig 18) This is neither a permanent dwelling, nor a

primary one. These are concepts not applicable to the Kaggaba residence pattern. Villages are not permanently occupied and serve as not much more than “convenient gathering places” used to; “exchange news, discuss community matters, fulfill minor ritual obligations, and trade with visiting Creole peasants” (Reichel-Dolmatoff 1978). They have multiple dwellings, with one located in association with each of the field crops tended. They are distributed both horizontally and vertically, ranging from seashore to an elevation of almost 2,000m (Oyuela-Caycedo 1998). Within the village complex is usually found a slightly larger house of very similar material construction. This would be the ceremonial house.

Countryside Temples



Figure 19. Field Temple

just outside the temple. (Figs 19-20) The countryside temples are never easy to access due to their being located on mountain ridges. They can either be of a style of construction called *bahío*, which is a hut with an apex and walls made of cane, or they can be of a beehive design (Oyuela-Caycedo 1998). The sources I was able to find do not provide specific dimensions for these types of temple structures.

Religious Hamlets

These are settlements which according to Oyuela-Caycedo have ties to “a mythical Kaggaba origin and more or less correspond to one male and one female house founded by one of the sons and

Called *Nuñhua*,

countryside or field temples have separate male and female structures. The M^áma, sometimes with his apprentice, live close to the fields. Retired priests occasionally take up residence in these temples as well. It is here that visiting neighbors would seek divination or counsel, which takes place on stone seats located



Figure 20. Stone seats of the field temple

daughters of the Universal Mother” (1998). Structures within these hamlets are rarely of differing architectural design and usually number less than a dozen temples, and are about 3-5 meters in diameter.

It is here in the hamlets that the Kaggaba established their intellectual centers. All are situated in the uppermost lands claimed by the Kaggaba, at elevations greater than 1900m above sea level. These huts have a circular base, half constructed of cane, the rest of mud walls. They have sticks, which radiate out from the temple roof apices, commonly appearing as sun rays projecting outward, others with different designs. This radial apex design is also found on female temple constructions within religious hamlets. They have, however, at their apex the added feature of randomly placed potsherds (1998).

The door of a male temple, called a *Nuñhuakala*, has an east/west of north/south orientation. Novice temples have their door oriented opposite that of their training priest. Within the temple, Kaggaba priests store ceremonial items such as sacred masks, trumpets and flutes used in ritual. At the time of publication of Oyuela-Caycedo’s article there was no information on female temples in the upper lands (1998). Space outside the temples is always provided for ceremonial dances and has stone slab seats, noted as a distinctive feature of religious hamlets where priests



Figure 21. Kaggaba men outside the men’s temple

practice divination. Adjacent to the dance floor area is where Mάma burials are located, and are “marked by an accumulation of stones.” The rest of the huts in the religious hamlets serve as homes to secondary house priests and their families (1998).

Ceremonial Villages

The Kaggaba occupy these villages only during times of ceremonial meetings or when the need for confession or council with the local M^áma. During these visits, men will spend most of their time in the men's temple associated with his house lineage. (Fig 21) Women, on the other hand, occupy their time almost exclusively with domestic chores, only occasionally assembling in the women's temple (Oyuela-Caycedo 1998).

Ceremonial hut structures are divided into secular and sacred constructions. Secular huts are constructed of mud wall and thatch, though in areas where the village is located among forestland, slats of cut palm replace those of thatch. They can either be circular or rectangular in shape. Women and children sleep and eat in these dwellings, while men sleep exclusively in the temple, which as Oyuela-Caycedo notes, serve as a type of men's clubhouse. M^ámas and their families have huts with a circular floor plan, with the only real difference being the presence of cane walls. As in the case of huts found in religious hamlets, ceremonial huts are usually about 3-5m in diameter (1998). (Fig 22)

The temples constitute the sacred spaces in ceremonial villages and are the site of divination. Temple structural complexity differs along gender lines. Male temples, with much heavier roofs contain extra center poles to support their roof weight. They have two doors which are oriented on an east/west axis.



Figure 22. Kaggaba religious hamlet and ceremonial huts

Additional roof supports are located just inside the main door entrance. A horizontal crosspiece adds additional roof support (1998).

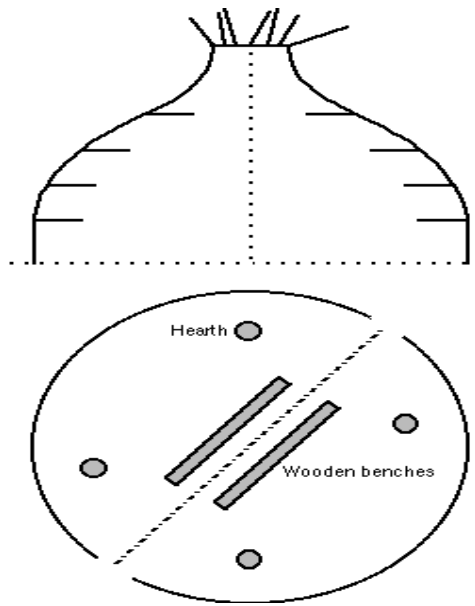

Figure 23 Ceremonial temple interior configuration

The male temples have log benches oriented along the same axis as the doors, along with four hearths which are associated with houses connected to the temple.

Hammocks are hung between the supporting poles (1998).

(Fig 23)

Implications of Religious Authority Reflected In Ceremonial Structures

As in the case, of the ceremonial chambers of the

Kotosh Religious Tradition sites, intimacy of ritual space

of Kaggaba ceremonial huts might lead one observing

their design to assume that religious practitioners would be shamans. Ritual and divination would be conducted with close proximity of all inside their temple structures. Nevertheless, as we see with KRT, the Kaggaba religious practitioners are highly trained priests whose authority extends beyond the realm of healing and negotiating with supernatural forces. Indeed, they possess both unquestioned sacred and secular authority. Similarities between the KRT and the Kaggaba, however, are limited to power and authority.

Conclusion

At the outset of this research project I sought to draw comparison between the religious ceremonial structures. A simple cursory examination of the two types and styles of constructions would first reveal the obvious. KRT ritual chambers and temples were stone structures, featuring recessed niches and single central hearths. As detailed above, Kaggaba ritual huts utilize no stone in their constructions. I was also hoping that by gaining insight into the social, political and religious structure of a contemporary culture living in a very similar habitat and environmental niche I might

be able to extrapolate a picture of religious life and practice of those immersed in the Kotosh Religious Tradition. After hundreds of pages of archaeological examination, and ethnographic research I have come to the conclusion that it is virtually impossible to compare these two extremely diverse culture groups.



Figure Kaggaba priest phoning in divination

While I might have been tempted to immediately leap to that conclusion at face value, it was necessary to first make sure by way of ethnographic study of the Kaggaba that my initial assumptions were indeed correct. As I reflect on the journey of discovery just completed, I am reminded of the comment Colin Renfrew made cautioning against either imposing our preconceived ideas about how religion was practiced, or even conceived, in prehistory (Renfrew 1994). Secondly, Gerardo Reichel-Dolmatoff analysis of the Kaggaba as being a culture in “continual transformation will be a constant reminder of a concept learned about culture by every first year undergrad, cultures change (Reichel-Dolmatoff

1976). (Fig 24) Regardless of isolation, resource limitations, or ideological continuity, the overall cultural dynamic will never remain static.

References

- Atkinson, Jane Monnig
1992 Shamanism Today. *Annual Review of Anthropology* Vol. 21: 307-330.
- Donnan, Christopher B.
1985 Early Ceremonial Architecture in the Andes: A Conference at Dumbarton Oaks. Washington D.C.: Dumbarton Oaks
- Fogelin, Lars
2007 The Archaeology of Religious Ritual. *Annual Review of Anthropology* Vol. 36: 55-71
- Grieder, Terence
1988 Art as Communication at La Galgada. In *La Galgada, Peru: A Preceramic Culture in transition*. Ed. T. Grieder. Austin: University of Texas Press
- Gullov, Hans Christian, and Martin Appelt
2001 Social Bonding and Shamanism Among Late Dorset Groups in High Arctic Greenland. In *The Archaeology of Shamanism*. Ed. by Neil Price. New York: Rutledge Press.
- Haas, Jonathan and Winifred Creamer
2004 Cultural Transformations in the Central Andean Late Archaic. In *Andean Archaeology*, ed. Helaine Silverman. Malden: Blackwell Publishing
- Moore, Jerry
2005 Cultural Landscapes in the Ancient Andes: Archaeologies of Place. Gainesville: University of Florida Press
1996 Architecture of Power in the Ancient Andes. Cambridge: Cambridge University Press
- Moseley, Michael
2001 The Incas and Their Ancestors. London: Thames and Hudson
- Oyuela-Caycedo, Augusto
2008 Late Pre-Hispanic Chiefdoms of Northern Colombia and the Formation of Anthropogenic Landscapes. In *Handbook of South American Archaeology*. Ed. Helaine Silverman and William Isbell. New York: Springer Press.
2001 The Rise of Religious Routinization: The Study of Changes from Shamanism to Priestly Elites. In *Mortuary Practices and Ritual Associations: Shamanic Elements in Prehistoric Funerary Contexts in South America*. BAR International Series 982. Oxford: Basingstoke Press.
1996 Ideology, Temples, and Priests: Change and Continuity in House Societies in the Sierra Nevada de Santa Marta. In *Recent Advances In The Archaeology Of The Northern Andes: In Memory of Gerardo Reichel-Dolmatoff*. Monograph 39 The Institute of Archaeology University of California, Los Angeles.
- Reichel-Dolmatoff, Gerardo
1982 Cultural Change and Environmental Awareness: A Case Study of the Sierra Nevada de Santa Marta. *Mountain Research and Development* Vol. 2 No. 3: 289-298.
-

1976 Training for the Priesthood Among the Kogi of Columbia. In *Magic and Religion: A Reader in the Anthropology of Religion*. eds. Pamela A. Moro and James E. Myers. New York: McGraw Hill

Renfrew, Colin, and Ezra B.W. Zubrow

1994 The Archaeology of Religion. In *The Ancient Mind: Elements of Cognitive Archaeology*. Cambridge: Cambridge University Press

Silverman, Helaine

2004 *Andean Archaeology*. Hoboken: Wiley-Blackwell.

Silverman, Helaine, and William Isbell

2008 *Handbook of South American Archaeology*. New York: Springer Press

Wilson, David J.

1999 *Indigenous South Americans of the Past and Present*. Boulder: Westview Press.

The Early Formative in Ecuador: The Curious Site of Real Alto

By Ana Cuellar

Department of Anthropology

Introduction

Valdivia villages are among the first villages found in South America. Valdivia culture sites are found on the Santa Elena Peninsula of Ecuador along the Chanduy, Valdivia, and Blanco-Ayampe valleys (Damp 1984a). Valdivia culture relates to the ceramic production in the region which also signifies the beginning of the formative period, or sedentary life, in Ecuador. Two general statements can be made about Valdivia ceramics. First, there are three distinct categories of vessel shape which consist of two pot forms and a bowl form. One pot has a tall, moderately concave neck and a nearly spherical body; the neck of which is decorated with incisions. The second pot form has a squat outline and a short neck. The bowl form is nearly hemispherical and covered with red paint (Lathrap, Collier and Chandra 1975). Secondly, there is clearly a conceptual distinction between pots and bowls. “There was apparently a clear conviction that decorative techniques appropriate to pots were inappropriate to bowls and vice-versa” (Lathrap, Collier, and Chandra 1975). While all Valdivia culture sites share various similarities, there is one site in particular which is strikingly different. The site of Real Alto, located on the Chanduy Valley, is an enormous site with large permanent religious structures and a large central plaza (Lathrap, Marocs, Zeidler 1977). Real Alto stands alone in that its primary function was religious, not residential. The following will discuss Real Alto’s features and its sequence of settlement changes. An attempt will also be made to uncover the causes behind these settlement changes leading to Real Alto’s eventual abandonment. It is my belief that landscape, architecture, and religious authority can affect the use and function of a space. If so, then the relative location of Real Alto, its site plan, and the religious ideology, shaped it into the ceremonial center it was to become.

Background to the Problem

True for all archaeological sites around the world is the problem of time. Determining which dates are relevant or correct can create more questions than answers. While most scholars would agree with Betsy Hill's eight period chronology for Valdivia culture sites, there is a great discrepancy on which dates fall into which period. For simplicity's sake, I will be referring to Lathrap, Marcos, and Zeidler's chronology. These individuals initially excavated the site and determined the sequence of settlement changes for Real Alto. The dates for each period are: Valdivia I from 3400 BC to 3300 BC, Valdivia II from 3300 BC to 3100 BC, Valdivia III from 3100 BC to 3000 BC, Valdivia IV from 3000 BC to 2900 BC, Valdivia V from 2900 BC to 2700 BC, Valdivia VI from 2700 BC to 2500 BC, Valdivia VII from 2500 BC to 2300 BC and Valdivia VIII from 2300 BC to 1500 BC (Lathrap, Marcos, and Zeidler 1977).

Initially, the problem was to determine whether or not Real Alto was unique or a template for other Valdivia sites. Very quickly, it became rather obvious that Real Alto was absolutely unique and that there were no other sites like Real Alto by the end of Valdivia culture in 1500 BC. The primary question became why does Real Alto stand out among other Valdivia sites? There are consistent

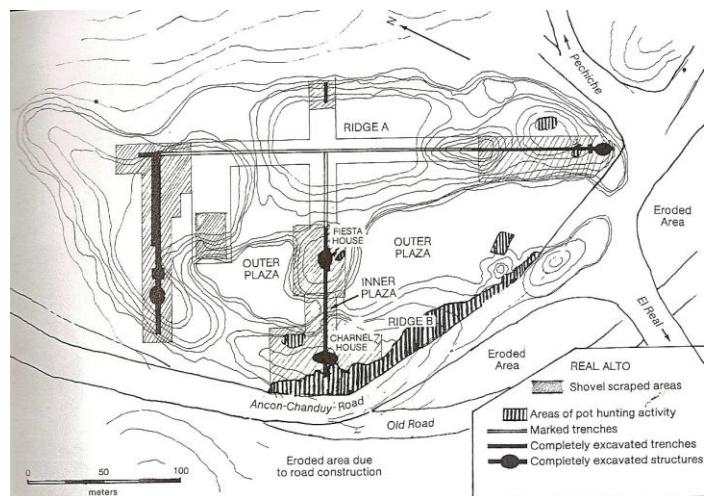

Real Alto's site plan
(Lathrap, Marcos, and Zeidler
1977)

similarities between Valdivia culture sites such as site size, layout and construction. So what could have led to the differences at Real

Alto? Since no sites are exactly the same, an analysis of the differences between sites laid out a clearer picture of what happened at Real Alto.

Analysis/Discussion

Real Alto

Real Alto is situated in the Chanduay Valley just off of the Rio Verde. It is a large site encompassing an area of three hundred by four hundred meters (Lathrap, Marcos, and Zeidler 1977). The site was first discovered by Jorge Marcos in 1971. Initial excavations, led by Donald Lathrap, Jorge Marcos, and James Zeidler, began in the summer of 1974 and lasted until fall of 1975 (Lathrap, Marcos, and Zeidler 1977). Though the original layout of the site was U-shaped (Damp 1984), by the end of Valdivian occupation the site was rectangular with a large central plaza (Lathrap, Marcos, and Zeidler 1977). Curiously, the central plaza contains no cultural debris; inhabitants at Real Alto did not live on or dump refuse on the central plaza (Lathrap, Marcos, and Zeidler 1977). Projecting into the plaza are two mounds. On the western edge of the plaza is the Charnel House mound and directly opposite to the Charnel House mound is the Fiesta House mound.

The Fiesta House mound projects from the eastern edge of the central plaza. Its shape is that of a truncated elliptical cone. It measures at “[...] fifty by thirty-seven meters at its base and thirteen by nine meters at the top. It rises 1.4 meters above the floor of the inner plaza [a depression between the two mounds]” (Lathrap, Marcos, and Zeidler 1977). The Fiesta House mound was originally built during the Valdivia III period and shows signs of being rebuilt at least eight times. At the top of the original mound, a basin like depression was excavated. The basin was filled with Valdivia III sherds and food remains such as razor clams, rock crab claws, lobster tails, scallop and chiton shells and sea turtles. These remains were mixed in refuse pits along with deer bone and drinking bowls. The door of the fiesta house opened to the west facing both the inner plaza and the Charnel House mound (Lathrap, Marcos, and Zeidler 1977).

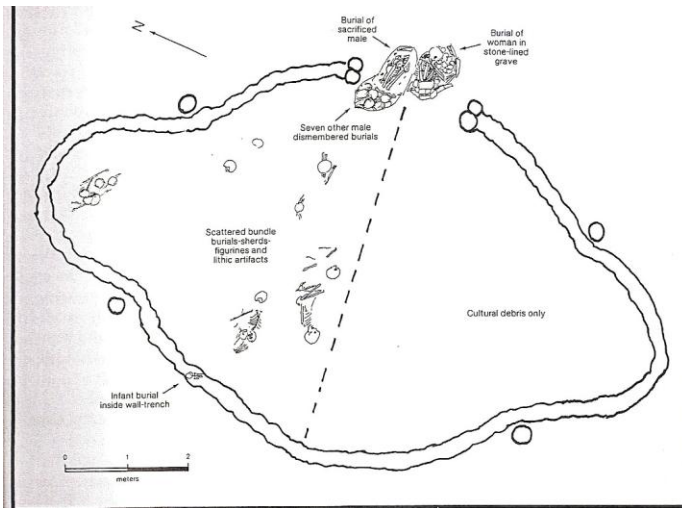

Plan of Charnel House mound (Lathrap, Marcos, and Zeidler 1977)

The Charnel House mound is on the western edge of the central plaza. The structure on this mound is different from all other constructions at Real Alto (Lathrap, Marcos and Zeidler 1977). It had an elliptical central precinct with two semicircular wings. At the center of the structure and facing the inner plaza was a

large door, about two meters wide, bounded by double posts. The entrance and the esplanade served as a sort of stage where mortuary

and sacrificial rites seem to have taken place. Inside the building, high ranking individuals were placed on racks as secondary, bundle burials. Underneath the threshold of the entrance, the burial of a woman was found. "The floor of the tomb was paved with manos (grinding stones), the sides were lined with halved matates (querns), and the entire tomb was partially covered with metates" (Lathrap, Marcos, and Zeidler 1977). To the side of the tomb was the burial of a male who had been dismembered. "The head, legs, and arms, were stacked at the bottom of the grave, the torso balanced over them, and the pelvis and thighs were placed facing upward on top of the torso" (Lathrap, Marcos, and Zeidler 1977). Among the material remains of the burial, suspected to be a sacrificial burial, were seven chert knives. These knives were most likely used to dismember the body. Just west of this burial were secondary burials of seven other males inside a common pit. It is believed that at one point, each of these males were in the position of the dismembered burial (Lathrap, Marcos and Zeidler 1977).

Sequence of Settlement Changes

Before Valdivian occupation, Real Alto was inhabited by a small, mobile group of people who practiced a fish gathering economy. Their remains are the earliest found at the site. These early inhabitants were most likely nomadic people who spent the entire year on the shore. The shallow midden they left behind consists mostly of shells of clamlike mollusks from the mangrove swamp in the Chanduy estuary. Their homes were small, flimsy and erected with flexible poles (Lathrap, Marcos, and Zeidler 1977). The fish-gathering peoples were replaced by Valdivians. Initially it was believed that Valdivia society was also dependent on marine resources. Evidence suggests however that Valdivians were agriculturists (Lathrap, Marcos, and Zeidler 1977). It is believed that Valdivians were egalitarian Tropical Forest villagers who moved into Real Alto with domesticated plants (Schwarz and Raymond 1996). Valdivian occupation at Real Alto began in 3400 BC or Valdivia I period. At this time the general layout of the site was U-shaped with a central plaza. Population gradually increased into Valdivia II period (Lathrap, Marcos, and Zeidler 1977). Towards the end of Valdivia II, intentional mounding up of refuse began at the opening of the “U”, forming the base for the Charnel House mound (Damp 1984, Lathrap, Marcos, and Zeidler 1977). During the Valdivia III period, the Fiesta House mound was constructed and the population at Real Alto peaked. It is at this time that houses at Real Alto became large and elliptical structures; measuring about twelve by eight meters. The size of these homes suggests they housed extended families rather than individual families. Using house size as a basis, it is estimated that population during Valdivia III was at least 1500 inhabitants. After Valdivia III, population at Real Alto began to decline. By Valdivia V, the entire northern portion of the site is abandoned. It appears that Real Alto’s inhabitants left the site and began forming small satellite communities around Real Alto. By the end of Valdivia VIII in 1500 BC, Real Alto completely loses its residential population (Lathrap, Marcos, and Zeidler 1977).

size is approximately 4.5m by 3.2m (Damp 1984a). True for all Valdivia Sites is the reliance on agriculture instead of marine adaptations once believed for this culture group. Valdivians moved into the area with domesticated plants, evidenced by at least three different plant species: maize, beans and cotton.



Valdivia Pot stamped with ears of maize and maize kernels (Lathrap, Collier and Chandra 1975)

Evidence of maize cultivation comes in the form of charred remains and ceramics stamped with maize kernels and ears of maize (M. Carlos et al. 1977). Carbonized *Canavalia* beans were found in situ in the refuse zone of a Valdivia I household (Damp, Pearsall, and Kaplan 1981). Carbonized cotton seeds were also found at Real Alto, dating to Valdivia I. 133 fragments and whole seeds were recovered (Damp and Pearsall 1994). Additional supporting evidence for agriculture were recovered at both sites; stone spindle whorls used for cotton production, and manos and matates used for maize processing were found inside houses (Damp 1984a). At both Real Alto and Loma Alta burials were found inside the home, or just outside the home. In some instances human remains were found underneath walls and underneath entrances. Marcos suggests that these burials were “dedicatory or guardian burials” serving as protectors of the structure (Damp 1984a).

With all these similarities between Real Alto and Loma Alta, how is it that Real Alto became a ceremonial center and Loma Alta did not? While Real Alto and Loma Alta shared many similarities, they were not exact copies of one another. It is in Real Alto’s differences that one can

begin to understand why Real Alto became such an important religious center. Real Alto was a coastal village at 1.5km from the coastline (Damp 1984a). While agriculture was the primary economic activity, marine resources and mangrove swamp resources could have been exploited to supplement the diet (Lathrap, Marcos, and Zeidler 1977, Klepinger 1979). Also, during Valdivia III period, there is a significant rise in the residential population at Real Alto. It is estimated that the population in Valdivia I and II periods was about 150 to 200 inhabitants (Damp 1984a) and it rose to 1500 inhabitants by Valdivia III (Lathrap, Marcos, and Zeidler 1977). With more people moving into Real Alto, the site itself expanded. During Valdivia III period, the central plaza extended past the Fiesta House mound and Charnel House mound to form a large rectangular village (Damp 1984, Lathrap, Marcos, Zeidler 1977). Finally, while not explicitly stated, there appears to be a shift in religious ideology. During Valdivia I and II, ceramic and bone carvings recovered indicate the practice of ecstatic shamanism. Snuff tablets, used for the inhalation of hallucinogenic drugs, were recovered, which are associated with shaman rituals. Also, a bone carving of a shaman sitting on a stool was recovered dating to early Valdivia (Lathrap, Collier and Chandra 1975). Moore argues that permanent architecture and the separation of religious and community architecture is indicative of canonist religious authority (Moore 2005). If this is the case, then the construction of the Charnel House mound towards the end of Valdivia II period and the construction of the Fiesta House Mound in Valdivia III period in the central plaza would indicate a belief in canonist ideology. The expansion of the site could also reflect this ideological change. Real Alto was originally 145m by 90m (Damp 1984a); but by Valdivia III the site expands to 300m by 400m. Moore also argues that a significant difference between shamans and canonists is in their conceptions of the duration of religious efficacy. "The impact of most ecstatic shamans is limited to an individual's lifespan. [...] In contrast, a canonist employs and perpetuates a body of sacred knowledge that may cycle through eons" (Moore 2005). While the residential population left Real Alto, it was by no means forgotten. Real Alto retained its power as a symbol beyond Valdivia culture. The evidence is in the absence of

evidence. That is to say that there is no evidence of another culture group over Valdivia in the central plaza. Real Alto's inhabitants during the Machalilla period between 1500 BC and 900 BC (Schwarz and Raymond 1996) did not remodel the site, nor did they leave cultural remains in the central plaza which contained the ceremonial structures.

Abandonment ... kind of...

Despite Real Alto's high population and large constructions, the site was eventually abandoned. The abandonment of the site can be attributed to two causes. First, with a shift in religious authority, it is likely that Real Alto became a ceremonial space strictly for specialists and elites. Canonists stratify society and rely heavily of the separation between commoners and religious specialists. Real Alto became a village with a "[...] dispersed rural "peasantry" on the one hand, and a cadre of full-time politico-religious specialists residing at Real Alto on the other" (Schwarz and Raymond 1996). Secondly, Valdivians' primary economic activity was agriculture. With such a large influx of people in Real Alto beginning in Valdivia III period, there simply was not enough farm land at the immediate site to meet the needs of the larger population. Evidence shows that people were moving out of Real Alto and filling in the valleys to occupy available farmland forming small satellite communities surrounding the site. Damp argues that the availability of farmland along the valley was responsible the settlement patterns among these satellite communities (Damp 1984b).

There is one minor implication in saying that Real Alto was abandoned due to shifts in religious authority and a need for suitable farmland, which is Real Alto wasn't really abandoned. To say that it was abandoned is misleading. While it is true that the residential population abandoned the site, it is likely that a class of religious specialists remained, or that inhabitants were periodically returning to the site. This is evident by the continuous upkeep of the Fiesta House mound after Valdivia III period (Lathrap, Marcos, and Zeidler 1977). Also, Lathrap, Marcos and Zeidler view Real Alto as a control center for the satellite communities that formed around it. They describe the

site as “regulating farmsteads dispersed along the river valley and controlling some 600 acres of agriculture bottomland” (Damp 1984b). While commoners did abandon the site, an elite class of specialists most likely stayed behind.

Summary

In summary, the Valdivia culture site of Real Alto was unique to other Valdivia sites. Real Alto’s main function, unlike other Valdivia culture sites, was to serve as a ceremonial center, perhaps exclusively for elites and religious specialists. Its relative location, architecture, and religious ideology shaped the community into what it was to become. The sites abandonment can be attributed to a shift in religious authority and the need for suitable farming land outside of the site. While the resident population abandoned the site, its power and influence was not forgotten, having survived long after the people responsible for its construction had gone.

Conclusion

Real Alto is among the first Valdivia culture sites found on the Santa Elena Peninsula in Ecuador. Its occupation spans all of Valdivia from 3400 BC to 1500 BC and into the following Machalilla period in the middle formative. In early Valdivia, Real Alto was not unlike other Valdivia sites like Loma Alta. However, beginning in Valdivia III period, changes within the community set Real Alto apart from all other Valdivia sites. Real Alto became a ceremonial center while no other villages did. Real Alto may have also controlled the small satellite communities that formed around the site. Real Alto became a ceremonial center, and was abandoned in part because of its proximity to the coast, giving inhabitants the ability to exploit marine and mangrove swamp resources. Its village layout and mound constructions, and its shift in religious authority from ecstatic shamanism to canonist, reflected in the site’s constructions, site size and influence throughout the Valdivia period.

Bibliography

- Damp, Jonathan E., Deborah M. Pearsall, and Lawrence T. Kaplan
1981 *Beans for Valdivia*. *Science, New Series* 212(4496):811-812
- Damp, Jonathan E.
1984 (a) *Architecture of the Early Valdivia Village*. *American Antiquity* 49(3):573-585
- Damp, Jonathan E.
1984 (b) *Environmental Variation, Agriculture, and Settlement Processes in Coastal Ecuador (3300-1500 B.C.)*. *Current Anthropology* 25(1):106-111
- Damp, Jonathan E. and Deborah Pearsall
1994 *Early Cotton from Coastal Ecuador*. *Economic Botany* 48(2):163-165
- Klepinger, Linda L.
1979 *Paleodemography of the Valdivia III Phase at Real Alto, Ecuador*. *American Antiquity* 30(2):305-309
- Lathrap, Donald W., Donald Collier and Helen Chandra
1975 *Ancient Ecuador: Culture, Clay and Creativity 3000-300 B.C.* Chicago: Field Museum of Natural History.
- Lathrap, Donald W, Jorge G. Marcos and James A. Zeidler
1977 *Real Alto: An Ancient Ceremonial Center*. *Archaeology* 30:2-13.
- M., Carlos Zevallos, Walton C. Galinat, Donald W. Lathrap, Earl R. Leng, Jorge G. Marcos and Kathleen M. Klumpp
1977 *The San Pablo Corn Kernel and Its Friends*. *Science, New Series* 196(4288):385-389
- Moore, Jerry
2005 *Religious Authority and Ceremonial Architecture in the Formative Andes. From Cultural Landscapes in the Prehispanic Andes: Archaeologies of Place*. University Press of Florida.
- Pearsall, Deborah M. and Dolores R. Piperno
1990 *Antiquity of Maize Cultivation in Ecuador: Summary and Reevaluation of the Evidence*. *American Antiquity* 55(2):324-337
- Schwarz, Frederick A. and J. Scott Raymond
1996 *Formative Settlement Patterns in the Valdivia Valley, SW Coastal Ecuador*. *Journal of Field Archaeology* 23(2):205-224
-

Ecstatic Shamanism or Canonist Religious Ideology?

By Samantha Glover

Department of Anthropology

Introduction

The purpose of this research project is to evaluate ancient Moche archaeological sites, specifically the sites of Pampa Grande, Galindo and Cerro Blanco in Peru, for evidence of religious ideology. It should be evident from the different types of ceremonial buildings and their architectural features, as well as the material remains discovered throughout the sites, whether or not canonist authority was present or if the main form of religious expression was orchestrated by ecstatic shamans. This hypothesis was first introduced by Jerry Moore in his book “Cultural Landscapes of the Ancient Andes: Archaeologies of Place.” I will apply his theory to the sites mentioned above, along with reference to Lawrence Sullivan’s definitions of ecstatic shamans and canonists in South America in order to evaluate ritual material remains and their significance. Finally, in order to evaluate crowd capacity within certain religious structures, I will employ John Fruin’s calculations on crowd dynamics (Fruin 1984).

Background to the Problem

Moore argues that sites with little or no ceremonial architecture are reflective of societies in which ecstatic shamanism is the main form of religious expression. A lack of large and elaborate ceremonial architecture is the result of the need for the societal members to experience firsthand the effects of the ecstatic shaman’s performance (Moore 2005: 88). Archaeological sites where ceremonial architecture is large scale and elaborately constructed with restricted areas for religious practices and excludes most of the cultural group, is evidence for canonist religious authority (Moore 2005: 121).

Sullivan describes ecstatic shamans as “A general practitioner of the arts of the soul, the shaman not only controls the ecstasy of his or her own soul but specializes in the knowledge and care of the souls of others” (Sullivan 1988: 390). This role is normally learned through apprenticeship and requires a great deal of time and effort to master. Canonists are those who master a body of religious authoritative knowledge that is closed to the members of the cultural group (Sullivan 1988: 388). This knowledge can be inherited through appointment, election or learned through initiation into various types of priesthoods. A portion of religious ceremonial experience is not intended to be viewed by all members of the group.

There are many archaeological sites in the Andes that represent Moche occupation (many of which are still undergoing excavation and analysis). However, I will limit my research to three sites where excavation has been extensive: Cerro Blanco, Pampa Grande and Galindo. These sites encompass the Moche III thru V cultural phases which is based on the generally accepted Early Intermediate Period chronology spanning AD 1 to AD 700.

Challenges in research on this topic are the result of a limited number of detailed site maps for areas currently identified with Moche culture, as well as the lack of intensive focus on residential areas within those sites. Further difficulties in analysis come from the reuse of Moche sites by other cultures after the fall of the Moche state, as well as the impact of weather and erosion on structures and material remains.

Analysis/Discussion

Pampa Grande

Pampa Grande is located in the Lambayeque Valley and is classified as a Moche V site with occupation from 600-700 AD (Haas 1985: 392). Intensive excavations at this site were conducted by Jonathan Haas (Haas 1985) and Izumi Shimada (Shimada 1994). The main ceremonial mound of Huaca Grande (Figure 1) is comprised of three levels.

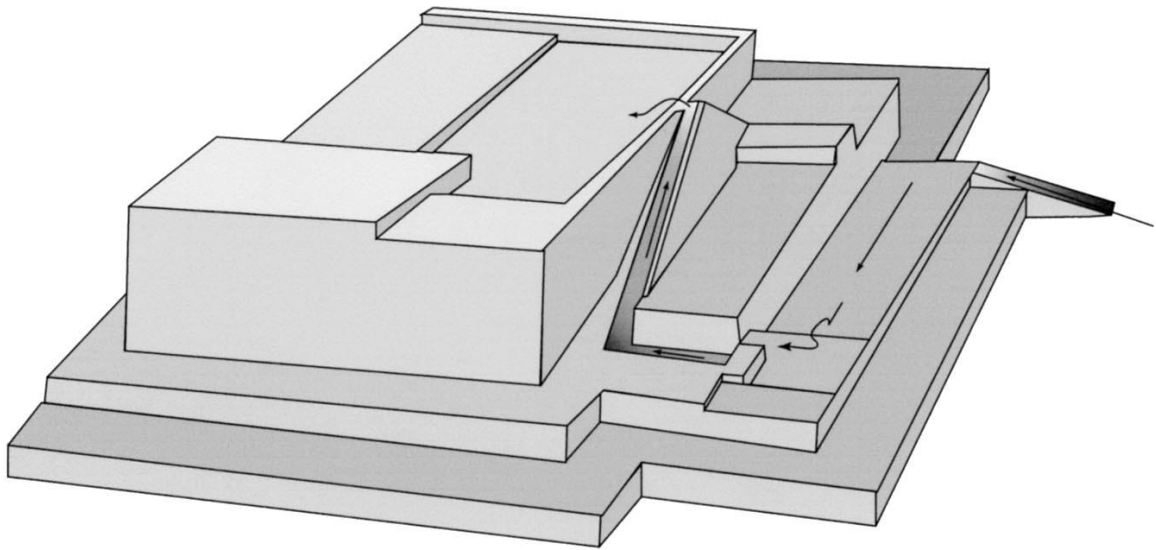

Figure 1. Huaca Grande at Pampa Grande (Quilter 2002: 182).

up the outside of the huaca to gain entrance. In order to enter the huaca, one must first pass through a series of checkpoints (Figure 2) leading to the first terrace. The checkpoints vary in width from 16 feet to 9 feet wide, which would allow approximately 2-3 people standing shoulder to

shoulder access through the checkpoints at any given time.

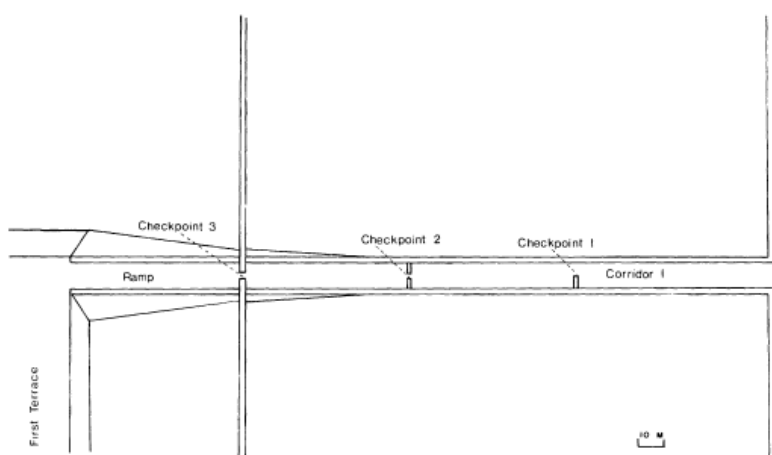

Figure 2. Entrance Checkpoints at Huaca Grande (Haas 1985: 396).

The first terrace is rather large (Figure 3), measuring 38,160 square feet, with a raised portion at the far end that was

probably used as a stage for ritual

the entry area, which also accounts

for a 1/3 of the total square footage of the first terrace was walled off into two roofed rooms, with unknown usage. This leaves the middle portion of the terrace open, and it is my conclusion that

because it faces the stage area it was the only portion of the huaca that could hold a relatively large amount of people for ceremonial purposes.

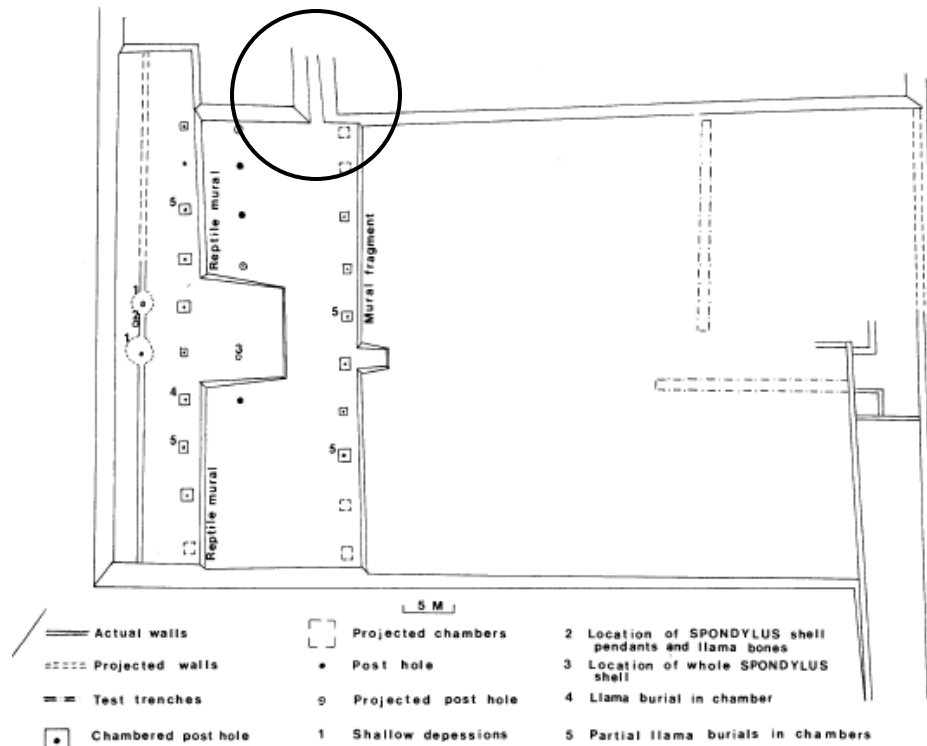

Figure 3. First Terrace with access to the third terrace located within the circular area (Haas 1985:399)

In order to understand how many people could be present on the first terrace for the purposes of viewing a religious ceremony, I employed Fruin's calculations on crowd dynamics. Fruin states that three square feet need to be allowed per person when calculating the amount of individuals able to occupy a given space (Fruin 1984). This calculation allows for some involuntary touching by individuals and permits maximum occupancy of space without dangerous crowd forces taking place. Based on Fruin's calculations, this would allow approximately 4,250 people to be present on the first terrace for any religious ceremonies. Since the approximate population of Pampa Grande during this time period is estimated at ten to fifteen thousand people (Shimada 1995:

9), this calculation suggests that ceremonial activity was not viewed by the entire population at any one given time and may have only been available to elites within the community.

Evaluation of the second terrace is extremely limited due to severe erosion (Haas 1985: 402). The access ramp to the third terrace is intact and is accessible only from the altar area on the first terrace. The location of this ramp suggests that access to the third terrace was extremely limited.

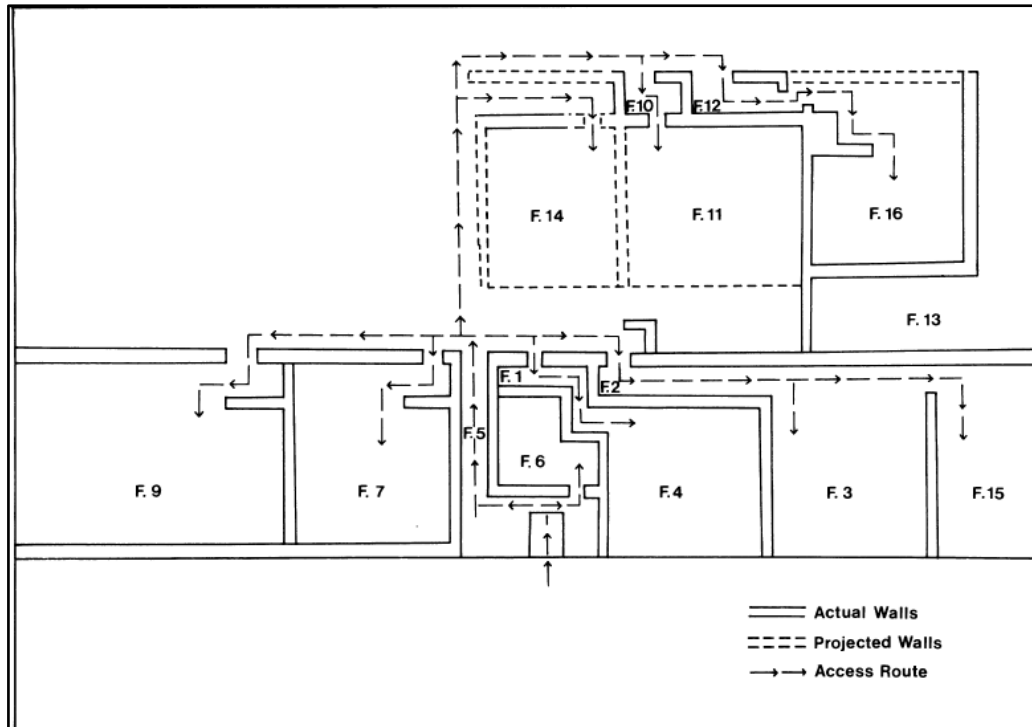

Figure 4. Terrace 3 showing possible access routes to each room (Haas 1985: 405).

On the uppermost level of the huaca are a series of rooms with indirect access through baffled doorways (Figure 4). All of the rooms contained evidence of ceremonial activity in the form of broken ceramic vessels, llama bones, quartz crystals and spondylus shell jewelry (Haas 1985: 402-407). There is debate over whether the rooms were strictly used for ceremonial purposes or as residences for elite societal members. Based on the artifactual assemblage, baffled entrances, lack of hearths and tools, and the location and size of the rooms I propose that the area was used for ceremonial purposes only.

Cerro Blanco

Excavations at the site of Cerro Blanco indicate it was occupied from Moche Phase 1 through Phase 4, however the dominant period of occupation is thought to have occurred during phase 3(AD 300-400) and phase 4 (AD 400-600) (Lockard)). There are two main religious structures, Huaca del Sol and Huaca de la Luna. Due to the severe erosion and looting of the Huaca del Sol I will be focusing my analysis on its architectural counterpart, Huaca de la Luna (Figure 5).

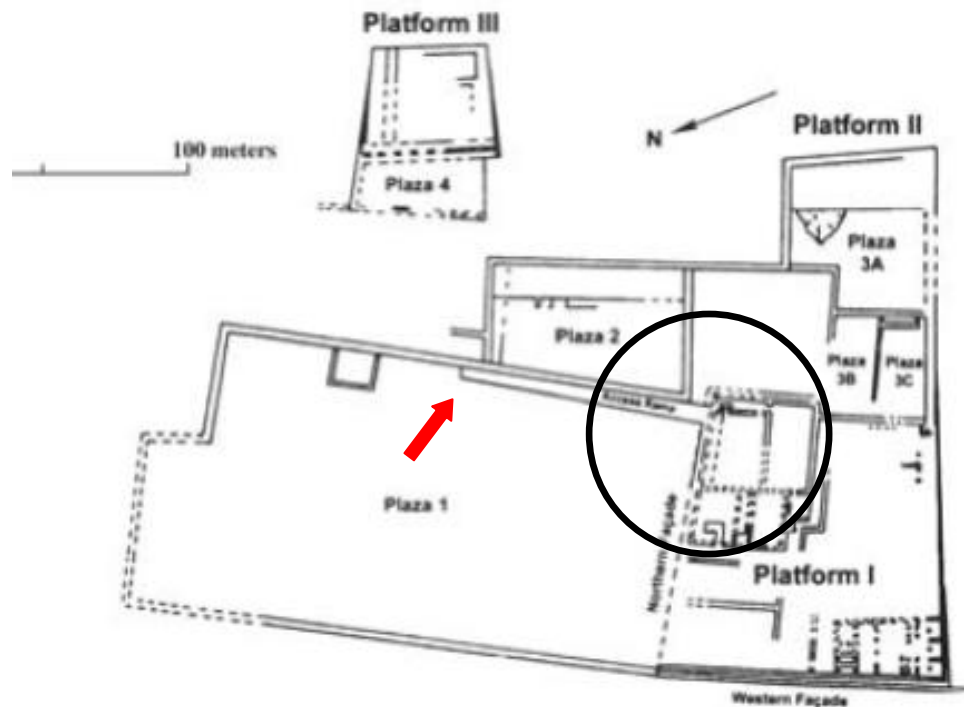

Figure 5. Site Map of Huaca de la Luna, Cerro Blanco. Red arrow indicates access to restricted area of the Huaca (marked with the circle) overlooking Plaza 1 (Uceda 2001).

Huaca de la Luna is comprised of three ceremonial platforms that at one time were connected, each surrounded by high walls decorated with elaborate polychrome murals (Moseley: 180). There are four plaza areas of various size and heights within the complex. The upper level of Platform 1 has two distinct room complexes on opposite sides of each other not accessible by the same access ramps. Figure 5 shows the access ramp leading to the northwestern room complex that overlooks Plaza 1. The narrow width of the ramp leading to a smaller enclosed area looking down

on the main plaza indicates that this was an area accessible only to those with authority within Moche culture. The nature of the huaca's use also suggests a great deal regarding the type of religious ideology present at the site since evidence of human sacrifice conducted on these platforms is abundant (Bawden 1999; 232).

Galindo

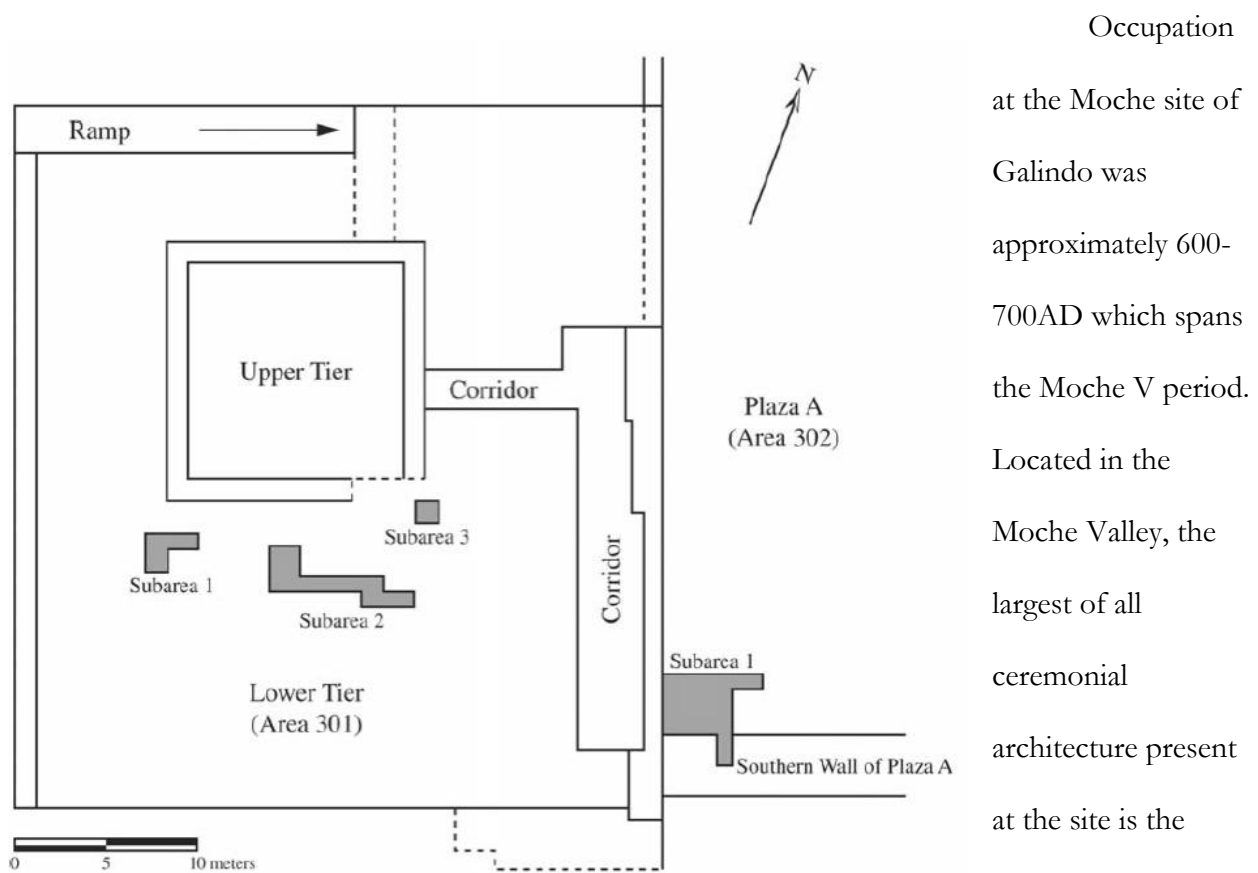

Figure 6. Site Map of Huaca de las Abejas at Galindo (Lockard: 2008:285)

Occupation at the Moche site of Galindo was approximately 600-700AD which spans the Moche V period. Located in the Moche Valley, the largest of all ceremonial architecture present at the site is the Huaca de las Abejas (Figure 6).

Excavations at the site have been performed by Gregory Lockard (Lockard 2008) and Garth Bawden (1982, 1995, and 1999) whose analysis will be the primary source of reference for my research.

The huaca is on the low end in size when compared to other Moche huacas, measuring 35 feet high at its highest point encompassing 368,916 square feet (Conrad 1974: 219). The uppermost

tier is a total of 2,436 square feet which based on Fruin's calculations would accommodate approximately 812 people. Access to this level appears to be extremely restricted with narrow winding corridors that cross seven ramps and three plaza areas (Conrad 1974: 226). This suggests that while a packed crowd of 812 people could have filled the upper tier to capacity, restricted access was likely reserved for elite members of the community.

Residential Evidence

Material remains provide undeniable evidence that shamanism was still practiced in people's homes despite the overarching presence of canonist religious ideology. These remains, in the form of gourd rattles, drums, figurines and fineware ceramics have been found in residential units in all of the sites

referenced above. At the site of Galindo nearly all residential

units have a "living room" area called the *sala* (Figure 7, Area C) where plainware votive figurines have been recovered (Bawden 1982: 169).

Bawden states that the *sala* was constructed of mud-plastered floors whereas other areas of the house have dirt packed floors (Bawden 1982: 169). Total square footage of the *sala* is an average of 267 square feet. Superior construction techniques, limited square footage and ritual items

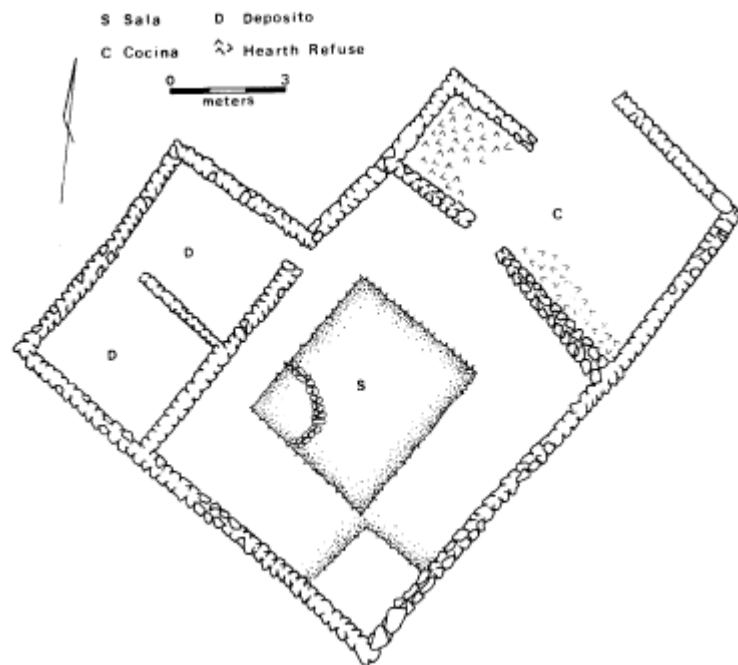

Figure 7. Typical Residential Unit at Galindo (Bawden 1982: 169)

recovered further suggest the area was meant to be an arena for spiritually based activities in the form of ecstatic shamanism.

The same architectural features represented at Galindo are found at Pampa Grande. Shimada's excavations reveal the house plans to be similar with mud-plastered floors present in the *sala* along with fineware ceramics and a bench area that may have acted as an altar (Shimada 1994: 169-171). While no figurines or other ritual paraphernalia were found, the similarities between the two locations suggest that commoners of Pampa Grande and Galindo practiced similar forms of ecstatic shamanism in the home.



Figure 8. Partial rattle in the shape of a two headed owl and partial figurine from Ciudad de Dios (Ringberg 2008: 349)

Gijseghem 2001: 261).

Other Moche residential sites, such as Ciudad de Dios (a Moche III-IV site in the middle Moche Valley with an occupation from 400-600 AD) have material remains in the form of gourd rattles, votive figurines and drums (Figure 8) (Ringberg 2008: 345-349). A lack of public and ceremonial architecture at the site

Residential units at Cerro

Blanco have widely varied architectural features which seem to reflect varied socioeconomic class distinctions and occupation levels. However, there are consistencies in artifactual remains indicative of shamanic activity such as fineware ceramics in what appears to be “living room” areas of many of the different residential units (Van

(Ringberg 2008: 345) further supports my theory that ecstatic shamanism was still practiced within the homes of the commoners during Moche rule.

Summary and Conclusion

It is my opinion that based on the architectural evidence from the Moche sites of Galindo, Cerro Blanco and Pampa Grande that the overarching religious ideology was canonist in nature, with the ruling elite presiding over religious ceremony to the exclusion of others within the community. This is evidenced in the highly restricted areas of the main ceremonial complexes, the limited crowd capacity for certain spaces within those complexes and the overall scale of the religious architecture.

Shamanism however was not stamped out by the ruling elite, with evidence coming from the excavations of residential areas within the same archaeological sites listed above. Material remains in the form of gourd rattles, drums, fineware ceramics and figurines not associated with mass production or workshops suggests that shamanism was occurring in the intimate setting of people's homes. The exclusion of certain societal group members from religious ceremony by the elite would have fostered the continued use of shamanism, since the overarching religious ideology could not aid the everyday spiritual needs of the community.

We can also look at present day Peru for evidence that shamanism has endured as an important religious ideology throughout the region's history. All one has to do is access newspaper articles and web blogs published at the time of the 2010 World Cup Soccer Tournament (an event that is hugely popular in contemporary Peruvian culture) to understand the prominence of shamanic activities. Images of modern day shamans blessing jerseys of their countries' team, performing outside of soccer arena's with gourd rattles (Figure 9) surprisingly similar to ones found

in ancient Moche sites, show us that shamanism has endured as a lasting religious practice in South America at least since the times of the ancient Moche cultural tradition.



Figure 9. Modern day shamans with gourd rattles during the 2010 World Cup

References

Bawden, Garth

1982 Community Organization as Reflected by the Household: A Study of Pre-Columbian Social Dynamics. *Journal of Field Archaeology*. Vol. 9, No. 2, pp. 165-181

1995 The Structural Paradox: Moche Culture as Political Ideology. *Latin American Antiquity*, Vol. 6, No. 3, pp. 255-273

1999 *The Moche*. Oxford: Blackwell Publishers Inc.

Conrad, Geoffrey

1974 Burial Platforms and Related Structures on the North Coast of Peru: Some Social and Political Implications. Tesis de doctorado. Harvard University

Fruin, John J.

1984 Crowd Dynamics and Auditorium Management. *Auditorium News*, May. Center for Venue Management Studies, International Association of Auditorium Managers

Haas, Jonathan

1985 Excavations on Huaca Grande: An Initial View of the Elite of Pampa Grande, Peru. *Journal of Field Archaeology*, Vol. 12, No. 4, pp. 391-409

Haley, Kevin J. and Stanish, Charles

2005 Power, Fairness and Architecture: Modeling Early Chiefdom Development in the Central Andes. *Archaeological Papers of the American Anthropological Association*, Vol. 14, pp. 53-70

Hastings, Mansfield and Moseley, Michael E.

1975 The Adobes of Huaca de Sol and Huaca de la Luna. *American Antiquity*. Vol 40, No. 2, pp. 196-203

Lockard, Gregory D.

2008 A New View of Galindo: Results of the Galindo Archaeological Project. In *Arqueología Mochica: nuevos enfoques*. Luis Jaime Castillo Butters, Hélène Bernier, Gregory Lockard, Julio Rucabado Yong, eds. Lima: Fondo Editorial de la Pontificia Universidad Católica del Perú.

Moore, Jerry D.

1996 *Architecture and Power in the Ancient Andes: The Archaeology of Public Buildings*. Cambridge: Cambridge University Press

2005 *Cultural Landscapes in the Ancient Andes: Archaeologies of Place*. Gainesville: University Press of Florida.

Moseley, Michael E.

2001 *The Incas and their Ancestors: The Archaeology of Peru*. Rev. Edition. London: Thames and Hudson.

Quilter, Jeffrey

2002 Moche Politics, Religion and Warfare. *Journal of World Prehistory*, Vol. 16, No. 2

Jennifer E. Ringberg

2008 Figurines, household rituals, and the use of domestic space in a middle Moche rural community. In *Arqueología mochica, nuevos enfoques*. . In *Arqueología Mochica: nuevos enfoques*. Luis Jaime Castillo Butters, Hélène Bernier, Gregory Lockard, Julio Rucabado Yong, eds. Lima: Fondo Editorial de la Pontificia Universidad Católica del Perú.

Shimada, Izumi

1994 *Pampa Grande and the Mochica Culture*. University of Texas Press.

Sullivan, Lawrence E.

1988 *Icanchu's Drum: An Orientation to Meaning in South American Religions*. New York: Macmillan Publishing Company.

Swenson, Edward R.

2006 Competitive Feasting, Religious Pluralism and Decentralized Power in the Late Moche Period. *Andean Archaeology III*, Part II, pp. 112-142

2008 San Ildefonso and the Popularization of Moche Ideology in the Jequetepeque Valley. In *Arqueología Mochica: nuevos enfoques*. Luis Jaime Castillo Butters, Hélène Bernier, Gregory Lockard, Julio Rucabado Yong, eds. Lima: Fondo Editorial de la Pontificia Universidad Católica del Perú.

Uceda, Santiago

2001 . Investigations at Huaca de la Luna, Moche Valley: An example of Moche religious architecture. In *Moche Art and Archaeology in Ancient Peru*, pp 47-68. Joanne Pillsbury, ed. National Gallery of Art, Washington DC.

Van Gijsegem, Hendrik

2001 Household and Family at Moche, Peru: An Analysis of Building and Residence Patterns in a Pre-Hispanic Urban Center. *Latin American Antiquity*, Vol. 12, No. 3, pp. 257-273

Wari Plazas: An analysis of Proxemics and the Role of Public Ceremony

By Audrey Dollar

Department of Anthropology

Introduction

The Wari Empire was a Middle Horizon (600 CE – 1000 CE) polity that expanded throughout much of present day Peru (figure 1). The known Wari settlements display a unique architectural style that distinguishes them from any other Andean architectural tradition. Donna Nash and Ryan Patrick Williams (2005) describe Wari architecture as “a material manifestation of power” that “holds important clues to understanding how Wari state officials managed resources and legitimized their control.” The idea that Wari was concerned with displaying their power through means of class segregation is one which is widely accepted.

One architectural feature that is shared between Wari and many other Andean architectural styles is the presence of plazas. The activities within these plazas range from intimate religious ceremonials, to large public feasts, to places for casual social interactions.

Determining the function of a plaza is no easy task, with many considerations necessary. First, what is the size of the plaza and how many people could fit into the space? Second, what architectural features are present, is the space oriented toward defined features, and what are the functions of these features? Third, what artifactual remains are present? Fourth, how restricted is access to the plaza? Can the activities taking place be seen by outsiders? Can the participants see the activities going on outside of the plaza? And finally, where is the plaza located within the site?

In this paper, I will be analyzing the proxemics of plazas at the Wari sites of Huari, Cerro Baul, Pikillacta, and Viracochapampa in terms of size and architectural features. I will then compare the results to the three architectural traditions discussed by Jerry Moore (1996) in his article, *The*

Archaeology of Plazas and the Proxemics of Ritual: Three Andean Traditions. The conclusion will address what these results imply about the role of public ceremony in Wari statecraft.

Background information

The Wari built their sites using a style of architecture that William Isbell (1991) has called



Figure 2

orthogonal cellular. This is a distinct style that has helped archaeologists to clearly distinguish Wari sites from other Andean entities. It consists of a large rectangular enclosure divided into quadrants, and then further divided into multi-storied patio groups of cell-like apartments with central patios (figure 2). These compounds were constructed of fieldstone, with access into them extremely limited. This style of architecture while present at all known Wari sites is not without variation.

The sites of Huari and Cerro Baul appear to have had a different function than the sites of Pikillacta and

Viracochapampa. The differences in architecture at these sites are not merely of size, but of scale.

Donna Nash (2002) points out that similar spatial venues or architectural features were used at different levels of the political hierarchy.” This is evident in the layout of the sites, as well as in the scale of their trademark orthogonal cellular building techniques, and the plazas that are contained within.

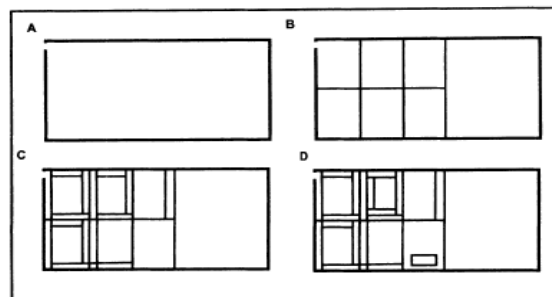

Figure 3. Ideal Wari architectural canon. Sites are constructed by building in the following order: A) a rectangular enclosure wall; B) internal square or rectangular grid divisions; C) and D) internal corridors, patios, and other architectural elements.

Figure 1



Figure 3

Analysis

In the following analysis, I will first discuss the plazas at the sites of Cerro Baul (figure 3) and Huari (figure 7). At Cerro Baul in sector E of the site, there is a structure that is uncharacteristic of Wari architecture. It is a 16 x 20 m tiered platform with a downhill staircase leading to a walled, 18 x 25m sunken court featuring a terraced gallery. Each of the terraces measure 20m long x 1m wide. These terraces probably provided a seating area from which activities on the platform could be viewed. If the terraces provided seating for 1 person per meter, the maximum occupancy of the terraces would have been 120 spectators (Nash and Williams 2005). The ceremonies performed at this location were probably linked to the natural environment, as the space is oriented towards the distant Picchu Picchu peaks with anyone present at the ceremony probably participating in the associated procession (Nash and Williams 2005). This large open space is uncharacteristic of the Wari and may have been used for public ceremonies that could be seen from the residential compounds below. They may have also served as a means of displaying the participants' power.

Cerro Baul was a colony with a population estimated at several thousand (Williams and Sims 1998). With that in mind, the low number of possible participants implies a level of exclusivity, with activities taking place visible to the settlements below, but lacking in detail.

On the other side of the site, in Sectors B and C, the public ceremonies were probably much more intimate. Both of these sectors feature a D-shaped temple, 10-12 meters in diameter with an adjacent plaza (figure 4) (Nash and Williams 2005). The plazas are larger than 10 meters squared, and have only one known entrance each. The plazas are enclosed within the walls of the compound, and activities that took place in the plazas were not visible to the outside world.

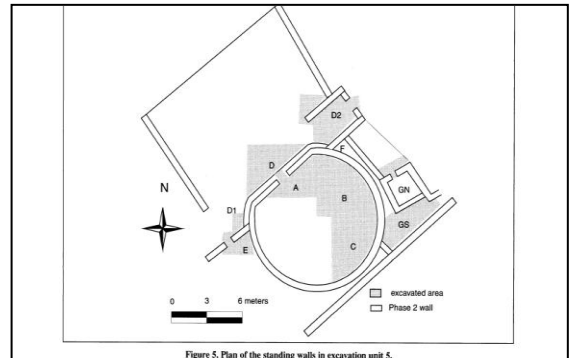

Figure 4

The size of the temples, when compared to the size of the adjacent plaza, suggest that all parties present were able to witness and participate in the activities going on in the plaza, but access to the temple itself was much more restricted. It is possible that only higher-ranking individuals were allowed to participate in the activities inside the temple, therefore legitimizing the social hierarchy of the colony.

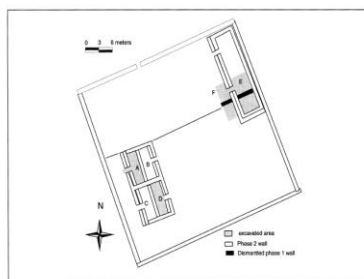

Figure 5

Figure 5

There are two other plazas in sector C, identified as the ceremonial center of the site, also housing the elite population. One of these plazas measures 25 X 25 m (figure 5). There is a complex of four 2.5 X 6 m rooms in the southwest area of the plaza (Williams 2001:12). Two of these

rooms have been interpreted as storage rooms with an additional two rooms yet to be excavated (Williams 2001:12). Also present is a structure in the northwest corner that is of superior masonry style, with double walls and interior benches (Williams 2001:12).

The other large plaza in this sector measures 50 X 25 m, with three side by side rooms, 10 X 3.3 m each, facing the plaza (figure 6). These rooms have interior benches that run the length of the wall and elevated 1 meter above the floor (Williams 2001:12). It is possible that this plaza was used for public ceremony, to pay a tribute to the elites seated in these rooms, though this is only speculation. More extensive excavations are needed to determine a more exact use of these large spaces.

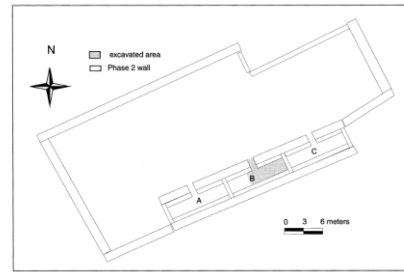

Figure 6

The site of Huari (figure 7) is commonly interpreted as the capital of the Wari Empire. The layout of the site is very similar to Cerro Baul, but it has not been as extensively excavated. The problem with interpreting Huari public spaces lies in the presence of multiple phases of construction and reorganization (Isbell and Vranich 2004).

The sector known as Vegachayoq Moqo (figure 8) was once the site of a large plaza. It had a patio, measuring 50 x 20m with an 8-9m high mound surrounding the east end (Isbell and

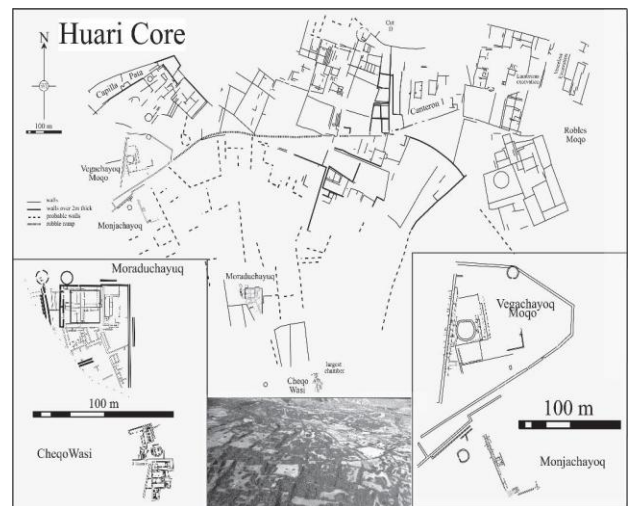

Figure 7



Figure 8

Vranich 2004) featuring roofed terraces. The terraces over the patio were probably occupied during ceremonial events by high-ranking officials displaying their superiority over the population (Isbell and Vranich 2004).

This plaza was later transformed to house a D-shaped temple that is easily compared to those seen at

Cerro Baul, although larger. This ceremonial building is distinct with 18 large niches and a doorway facing north. Based on the presence of niches, this building is thought to have had a mortuary function (Isbell and Vranich 2004).

The Moraduchayoq Compound (figure 9), is an enclosure having a 20 x 30m plaza at the east end of the compound. This plaza has one entrance and has a raised, east facing platform against the west wall (Isbell and Vranich 2004). This may have been a ceremonial center for the residents of the compound, with the platform used as a seating area for the elite residents, allowing face to face interactions between them and their approaching subordinates.

As is the case at Cerro Baul, the numerous patio complexes each featured their own central plaza. These areas probably served multiple functions, but a lack of architectural features and

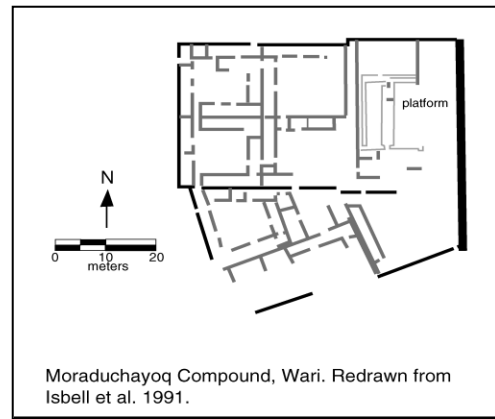

Figure 9

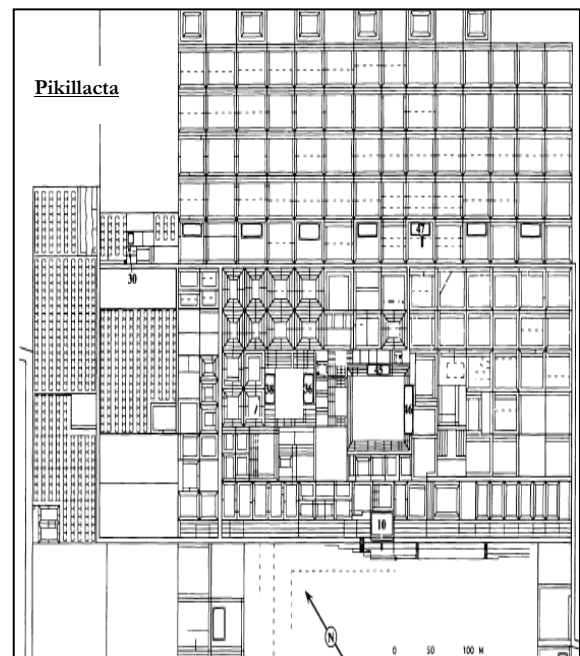
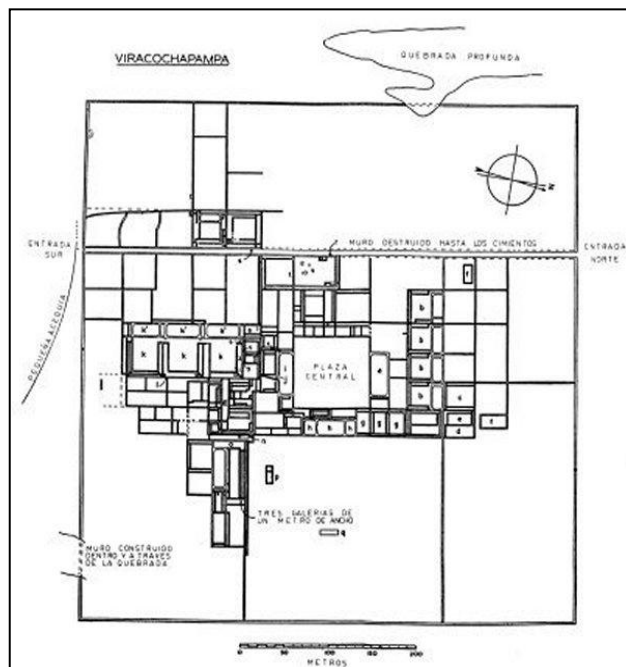

Figure 10

artifactual remains within the plazas make it difficult to determine a specific use.

The sites of Pikillacta and Viracochapampa (figure 10) utilize the same trademark Wari architectural features as Huari and Cerro Baul, however the layouts of the sites are very different. These sites are huge, entirely walled compounds that have been interpreted as second-tier administrative centers (Isbell and Schreiber 1978). These sites are both great examples of orthogonal cellular architecture, with multi-storied, patio groups that are repetitive throughout the structures. Both of these sites have large central plazas to which access is highly restricted and the activities within are tightly controlled.

It is important to note that at the time of abandonment, Pikillacta was still under

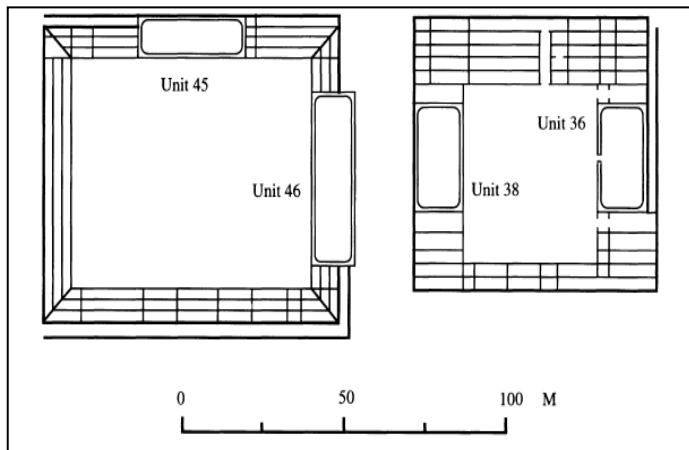

Figure 11

construction with the central sector the only one that is thought to have been finished and occupied (McEwan 1998). Viracochapampa was still in the early phases of construction and is not thought to have had a resident population (Jennings 2006).

The large central plazas at the two sites are remarkably similar, differing only in size and in the placement of niched halls along the perimeter of the plazas. Pikillacta has two central plazas (see figure 11), one measuring 90 X 95m, and the other 65 X 65m (Cook 1992:3). The central plaza at Viracochapampa measures 90 X 75m. These plazas could accommodate large numbers of people, but not the whole population at one time.

Along the perimeter of these central plazas are niched halls (see figure 12). The niched halls appear to have been roofed structures featuring rounded corners and large wall

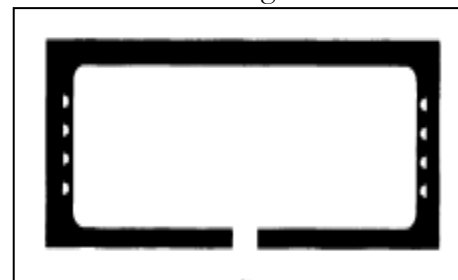

Figure 12

niches. In the corners and underneath the entry way of the niched hall, archaeological remains of camelid bones and spondylus shells have been recovered. These niched halls are accessible only from inside the plaza and have only one entrance. Access into the plaza was tightly controlled and therefore, access to these niched halls was also tightly controlled. These features and remains have lead archaeologists to believe that these plazas served religious and ceremonial functions (McEwan 1998).

The plazas at these two sites were probably used for public ceremonies that focused on

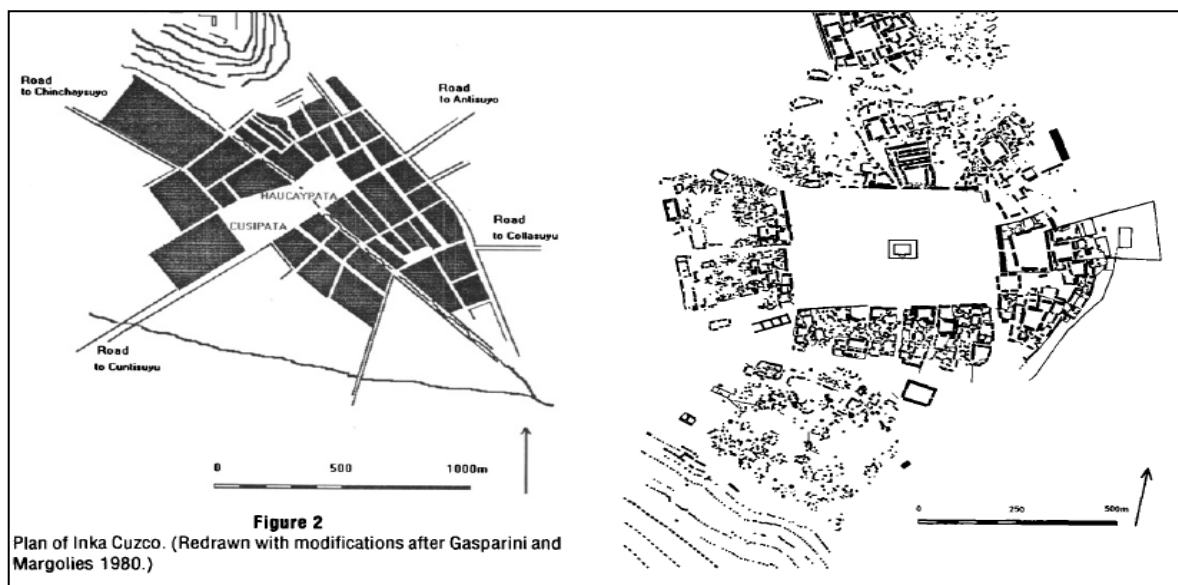

Figure 13

ancestor worship and lineage. The conquered people could be integrated into the Wari society more easily by the use of fictive kin (McEwan 1998).

Architectural Traditions

The three traditions discussed in Moore's (1996) article, *The Archaeology of Plazas and the Proxemics of Ritual*, are: (1) Inca, (2) Chimú, and (3) Charipá, Pucara and Tiwanaku plazas.

In the Inca tradition (figure 13), large, central, open air plazas were used for public ceremony and festivals (Moore 1996). The plazas were usually associated with a shrine. These plazas were considerably larger than those of the Wari, covering over 50,000 meters squared (Moore 1996).

There were no high perimeter walls of the plazas, so the activities that took place were visible to anyone in the vicinity.

In the tradition of Charipa, Pucara and Tiwanaku (figure 14), the plazas were very distinct. They were rectangular or square sunken courts encircled by terraces for viewing the

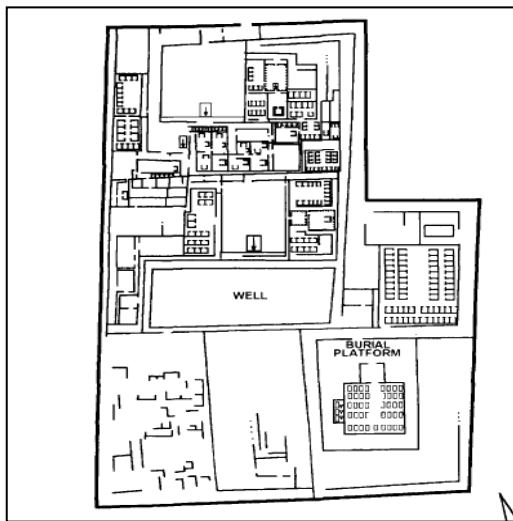

Figure 15

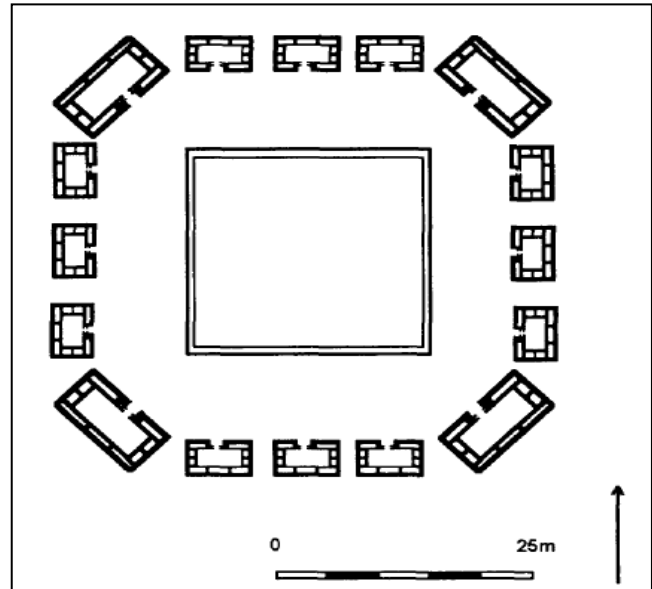

Figure 14

events taking place (Moore 1996). Plazas were enclosed by the terraces, making it difficult for an outsider to view the activities, but access was not tightly controlled.

The Chimu architectural tradition (figure 15) lacks large, central plazas, although plazas are present.

Moore (1996) describes these plazas as being “large unroofed spaces, located behind large adobe walls, entered through baffled entryways that are easily controlled”. These plazas are large, enclosed areas that are directly incorporated into a specific lord’s residence (Moore 1996).

Comparison

I have taken the chart (table 1) and graph (figure 16) from the article written by Moore (1996) and incorporated into them main plazas at the four Wari sites that I have discussed. The chart lists the traditions, individual sites within the traditions, and the dimensions of the plazas at the sites. The graph demonstrates the variations in the size of these plazas. It is important to note that the plazas located within the numerous smaller patio groups present at the Wari sites have been

omitted due to the vast number of them. The plazas included may have been used for larger, more public functions.

At Huari and Cerro Baul, the layout of the site is spread out, with the orthogonal cellular enclosures placed throughout different sectors, enclosing plazas within various compounds. It seems that the larger plazas located within the various sectors were reserved for specific groups of people, possibly the elites.

At Pikillacta and Viracochapampa the main plazas are large and central in the enclosure. The plazas are flanked by niched halls that likely provided a space for ancestor worship. Evidence of the ceremonial nature of these halls lie in the offering pits associated with the halls, as well as the lack of architectural features in the main plaza area.

Although the plazas at Pikillacta and Viracochapampa are comparable in size to those identified in the Inca tradition, it seems unlikely to me that the Wari plazas served the same purpose as those of the Inca plazas. It is possible that ceremonies of similar nature were carried out in these plazas, but the ease of access and organized viewing areas in the Inca tradition make me hesitant to draw any parallel to Wari.

The plazas in the Charipa, Pukara and Tiwanaku tradition are not

Culture		Dimensions	Area (m ²)
Inca	Haucaypata	190 x 165	31350
	Cusipata	180 x 130	20125
	Chincheros	114 x 60	6800
	Tambo Colorado	130 x 82	8580
	Willka Waman	195 x 120	18730
	Tombebamba	95 x 75	6318
	Ollantaytambo	72 x 72	5184
	Squier	71 x 58	4118
	Tshudi	76 x 71	5396
	Chimu	Rivero	83 x 73
Laberinto		82 x 82	6724
Gran Chimú		77 x 73	5622
Velarde		58 x 56	3248
Bandelier		84 x 76	6384
Uhle		86 x 74	6364
Tello North		58 x 55	3190
Tello South		53 x 38	2014
Manchan		140 x 80	11200
Farfan		69 x 60	3600
Charipa, Pucara and Tiwanaku	Charipa	22 x 23.5	517
	Pucara	16 x 15	240
	Akapana	45 x 45	2025
	Putuni	51 x 41	2091
	Semisubterranean Temple	26 x 28.5	746
	Lukurmata	9.49 x 9.5	90
Wari	Omo	10.5 x 10.5	110
	Cerro Baul Sector A	10 x 10	100
	Cerro Baul Sector B	14 x 10	140
	Cerro Baul Sector C	35 x 28	980
	Cerro Baul Sector C Unit 3	25 x 25	625
	Cerro Baul Sector C Unit 6	50 x 25	1250
	Cerro Baul Sector E	20 x 18	360
	Pikillacta A	90 x 95	8550
	Pikillacta B	65 x 65	4225
	Viracochapampa	90 x 75	6750
	Huari - Vegachayoq Moqo	50 x 20	1000
	Huari -Moraduchayoq	30 x 20	600

Table 1

easily compared to the Wari tradition. The size of the plazas in this tradition can be compared to the plazas at Huari and Cerro Baul, however the architectural style is vastly different, with the exception of one plaza at Cerro Baul. This plaza is a sunken court with a terraced viewing area, but the terraces do not surround the sunken court as they tend to do in the Charipa, Pukara and Tiwanaku tradition, leading me to believe that these are only superficial similarities.

There are definite similarities in the architecture and spatial orientation of the Chimú and Wari plazas, and to some extent, size can be used in comparison as well. The Chimú plazas are similar in size to the plazas at the Wari sites of Viracochapampa and Pikillacta, but they are much larger than those at Huari and Cerro Baul. It would not be wise, to draw any parallels based on size alone. The main similarity is that they were walled enclosures with restrictive access, as is the case with the plazas at each of the four Wari sites. High walls surround the plazas, marking social boundaries and demonstrating the exclusivity of the activities within these walls.

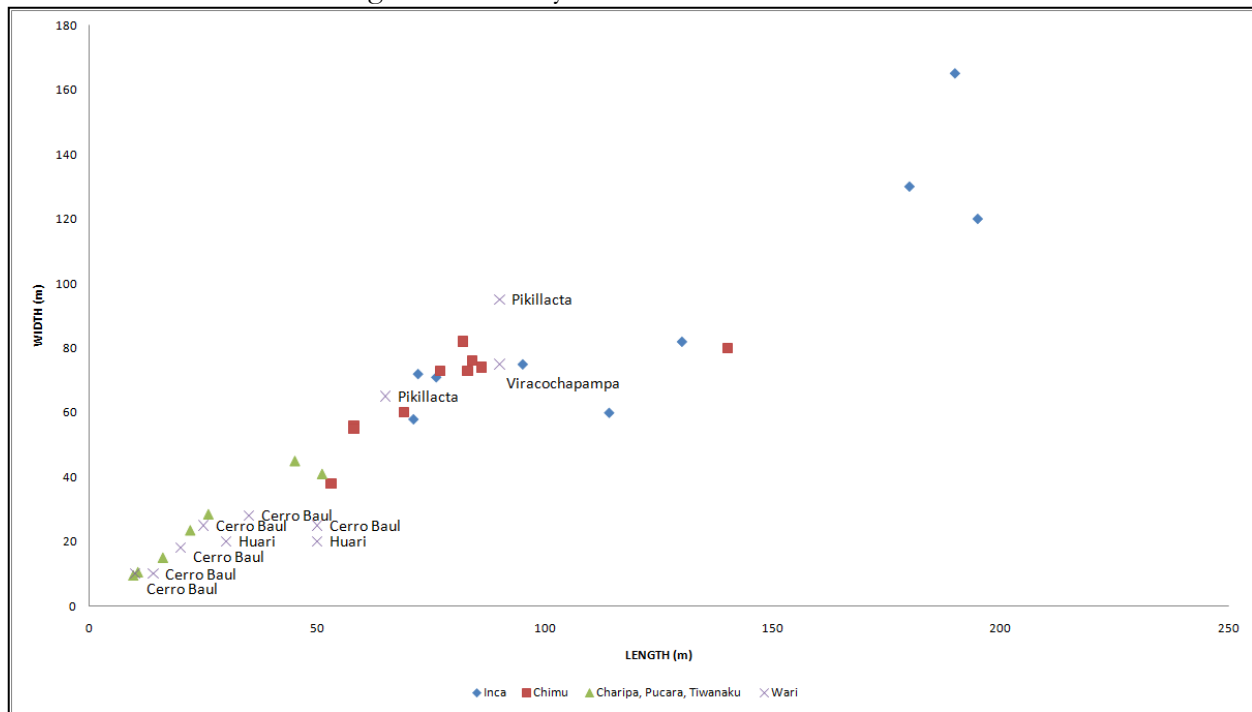

Figure 16

Chimú architecture does not feature plazas that are centrally located, nor do the sites of Huari and Cerro Baul. The Chimú incorporated their plazas directly into the lord's residence

(Moore 1996), and similarly, the Wari plazas are thought to be in close proximity to elite residences. This similarity marks the importance of plazas along with the elite's attempt to demonstrate their superiority and power over the general population.

Conclusion

My research and analysis has led me to believe that Wari plazas served a similar function to those of the Chimu tradition. The location of the plazas in relation to the elite residences reflects the importance of public ceremony in the Wari Empire. As Moore (1996) has stated, the walls in the Chimu tradition were used as a means of social control, clearly marking the distinction between insiders and outsiders. This is likely the case at the Wari sites as well.

I believe that the main differences in plazas between the sites of Huari, Cerro Baul, Viracochapampa, and Pikillacta are due primarily to the latter two sites being highly intrusive administrative centers. The large, central plazas featured niched halls, where the conquered population could be integrated into Wari society by means of ancestor worship and the use of fictive kin. These spaces appear to have served not only the purpose of integration, but also as a display of control and power the empire had over its conquered resident population.

At Huari and Cerro Baul, plazas were probably used in a similar way, but on a smaller scale. The presence of numerous, smaller plazas throughout the site, indicate a grand display of power was not needed or valued. I believe that the residents already knew their place within the society, and they were probably housed among their existing kin groups. Religious ceremonies and celebrations may have been contained within individual, smaller sectors of the site, which would be accessible only to the residents of that particular sector.

I believe that the Wari Empire had a unique architectural tradition. Although many similarities to Chimu do exist, the Wari appear to have incorporated architectural features which functioned specifically to the needs of each site. I conclude that the role of public ceremony in Wari

statecraft was dependent on the social situation of a given site, serving as an adaptive method of incorporation, class distinction and social control.

Bibliography

Cook, Anita G.

1992. The Stone Ancestors: Idioms of Imperial Attire and Rank among Huari Figurines. *Latin American Antiquity* 3(4): 341-364.

Hall, Edwin T., Ray L. Birdwhistell, Bernard Bock, Paul Bohannon, A. Richard Diebold, Jr., Marshall Durbin, Munro S. Edmonson, J.L. Fisher, Dell Hymes, Solon T. Kimball, Weston La Barre, Frank Lynch, S. J., J. E. McCellan, Donald S. Marshall, G. B. Milner, Harvey B. Sarles, George L. Trager, Andrew P. Vayda

1968. Proxemics. *Current Anthropology* 9(2/3): 83-108.

Isbell, William H.

2008. Wari and Tiwanaku: International Identities in the Central Andean Middle Horizon. *In Handbook of South American Archaeology*. Edited by Helaine Silverman and William H. Isbell. pp. 731-739. New York: Springer.

Isbell, William H., and Katharina J. Schreiber

1978. Was Huari a State? *American Antiquity* 43(3): 372-389.

Isbell, W. H. and A. Vranich

2004. Experiencing the Cities of Wari and Tiwanaku. *In Andean Archaeology*. Edited by Helaine Silverman. pp. 167-182. Blackwell, Oxford.

Jennings, Justin

2006. Understanding Middle Horizon Peru: Hermeneutic Spirals, Interpretive Traditions, and Wari Administrative Centers. *Latin American Antiquity* 17(3): 265-285.

Jennings, Justin and Willy Yopez Alvarez

2001. Architecture, Local Elites, and Imperial Entanglements: The Wari Empire and the Cotahuasi Valley of Peru. *Journal of Field Archaeology* 28(1/2): 143-159.

McEwan, Gordon F.

1990. Some Formal Correspondences between the Imperial Architecture of the Wari and Chimú Cultures of Ancient Peru. *Latin American Antiquity* 1(2): 97-116.

1991. Investigations at the Pikillacta Site: a Provincial Huari Center in the Valley of Cuzco. *In Huari Administrative Structures*. William H. Isbell and Gordon F. McEwan, eds. Pp.93-120. Washington, D.C.: Dumbarton Oaks.

1996. Archaeology Investigations at Pikillacta, a Wari Site in Peru. *Journal of Field Archaeology* 23(2): 169-186.

1998. The Function of Niched Halls in Wari Architecture, *Latin American Antiquity* 9(1): 68- 86.

Moore, Jerry D.

1996. The Archaeology of Plazas and the Proxemics of Ritual. *Three Andean Traditions*. *American Anthropologist* 98(4): 789-802.

Moseley, Michael E., Donna J. Nash, Patrick Ryan Williams, Susan D. deFrance, Ana Miranda, Mario Ruales.

2005. Burning down the Brewery: Establishing and Evacuating an Ancient Imperial Colony at Cerro Baul, Peru. *Proceedings of the National Academy of Sciences of the United States of America* 102(48): 17264-17271.

Nash, Donna and Ryan Patrick Williams

2005. Architecture and Power on the Wari – Tiwanaku Frontier *American Anthropological Association* 14: 151-174.

Williams, Patrick Ryan

2001. Cerro Baul: AWari Center on the Tiwanaku Frontier. *Latin American Antiquity* 12(1): 67-83.

Architecture, Agriculture, and Imperialism

By Joseph Schaefer

Department of Anthropology

This paper will attempt to show how Chimu imperial policies are reflected in the site of Quebrada Santa Christina in the Casma Valley of Peru. The site is unique because of how quickly it developed as an agricultural center and then abandoned, despite its short distance from the regional capital of Manchan. The site of Quebrada Santa Christina is located a short distance from the coast of the Casma Valley, several kilometers North West of the regional capital of Manchan. The site

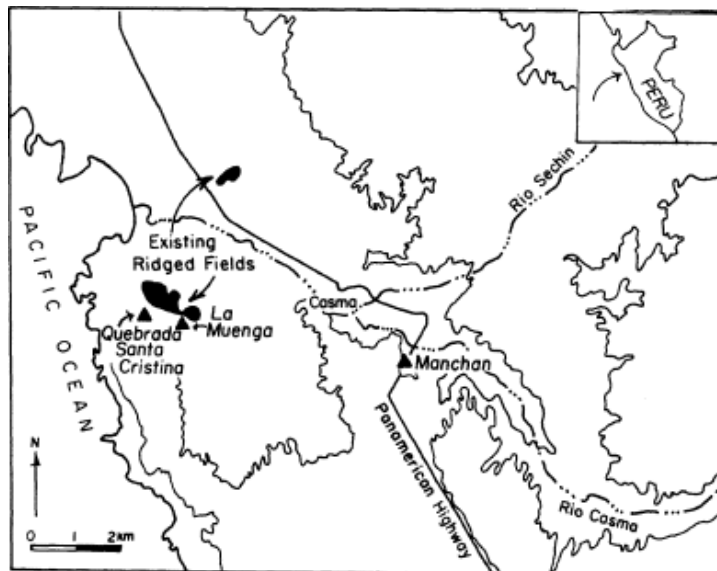

Figure 1, Contour map of the mouth of the Casma Valley showing Quebrada Santa Christina, extant of the raised fields in 1986, La Muenga, and Manchan

consists of remnants of prehistoric raised fields and a cane structure village. Most of the area under prehistoric cultivation has been heavily damaged by modern cultivation. Approximately 280 hectares of exposed prehistoric fields remained in 1986, 240 hectares of which are located south of the Rio Casma, where the remaining 40 hectares are located north of the Rio Casma (Moore: 1988).

The fields are located in a fossil bay and the community is located along the ancient shoreline. Approximately 2000 years ago, likely due to seismic activity, the water level dropped roughly 2 to 3 meters and exposed the current surface. The area has maintained a relatively shallow water table and local geography causes it to drain poorly (Pozorski, et al: 1983).

Based on data gathered and calculated by Dr. Jerry Moore, it is estimated that it would take between 134 and 600 man-years to construct the fields. This means that 600 men or fewer could construct the fields in a year or less (Moore: 1988).

The fields reclaimed boggy land for agricultural use utilizing passive irrigation. There would be no need for a canal to direct water to the fields. These fields were irrigated by a shallow water

table, although a canal was excavated in antiquity in order to facilitate faster drainage of the land. Pollen analysis shows that maize, root crops, and medicinal plants were grown in the fields (Moore: 1988).

The community of Quebrada Santa

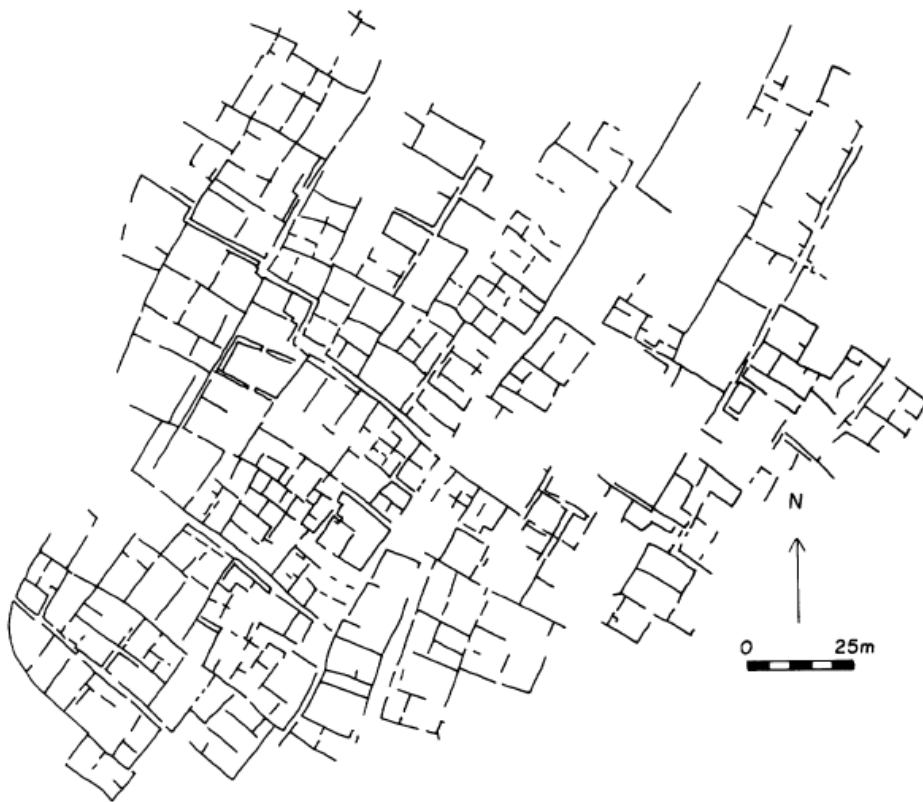

Figure 2, Community of Quebrada Santa Christina

Christina appears to

be a planned residence for agricultural workers and was utilized for a short period of time prior to its abandonment. The village consists of 284 rooms covering 3.11 hectares and was constructed of woven cane walls without cobble foundations. Most of the village consisted of residential units ranging in size from 9 to 15 meters squared with communal kitchens scattered throughout. Several long alleyways crisscross the site. There is sparse evidence of domestic debris, which indicates

short-term occupation, and no evidence of remodeling, which would have been necessary to maintain the woven cane walls. Since no perishable food remains were found the village appears to have relied on storable crops such as, maize and beans. However, there are no storage facilities in the village (Moore: 1988).

Stone agriculture implements, known as ‘doughnut stones’, were found in the village and in the fields. Additionally ceramic sherds of Late Intermediate style were found in the fields and were of the same style as those found in the village. The evidence indicates that the village and the fields were contemporary and that the village was occupied by agricultural workers during the reign of the Chimú Empire (Moore: 1988).

On the south side of the fossil bay exists a site known as La Muenga. The site covers approximately 10 hectares and consists of several low-walled stone structures mixed among cane walled structures. It has been heavily damaged by erosion, however several structures remain. These structures have internal divisions and low platforms, although they lack relation to an *audiencia*, which is an administrative node. This is consistent with administrative centers found in nearby Manchan. Between La Muenga and the ridged fields is a low stone and earth wall. The existing structures are aligned alongside this wall and similar ceramic sherds have been recovered on either side indicating that the wall, the fields, and La Muenga existed contemporaneously (Pozorski, et al: 1983).

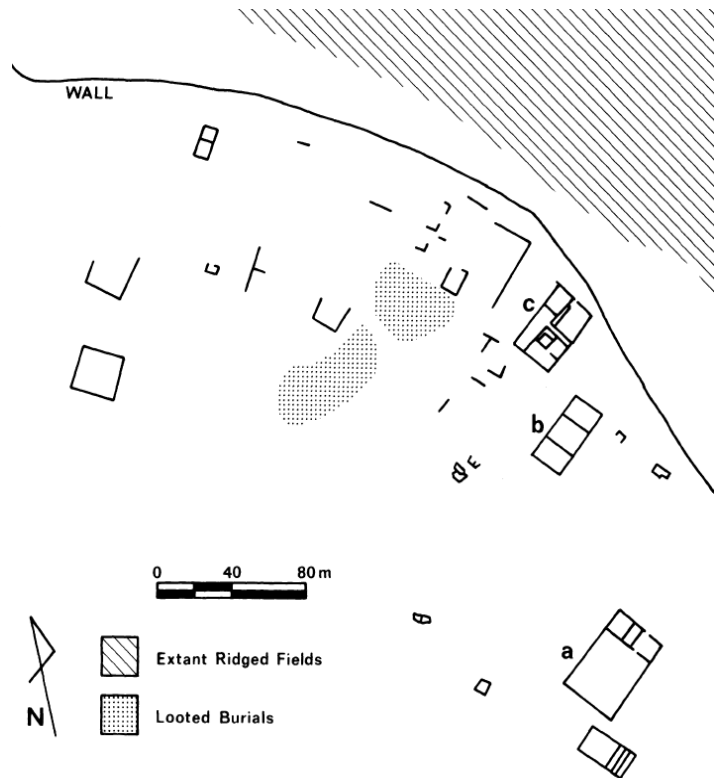

Figure 3, Plan view of La Muenga

North of the wall, outside La Muenga, is a long wide canal and causeway leading nearly to the ocean's edge. These canals seem to function as drains, where causeways were produced using the material excavated from the canals (Pozorski, et al: 1983).

To establish the fields and community of Quebrada Santa Christina as a rural agricultural outpost of the Chimú Empire, we must look to other known Chimú agricultural outposts for comparison. A good site to start with is Cerro la Virgen.

The site of Cerro la Virgen is a Chimú agricultural center located along the coast of the Moche Valley, 100 miles north of the Casma Valley. It consists of at least 400 small agglutinated rooms over an area of approximately 14 hectares on either side of a prehistoric trans-valley road.

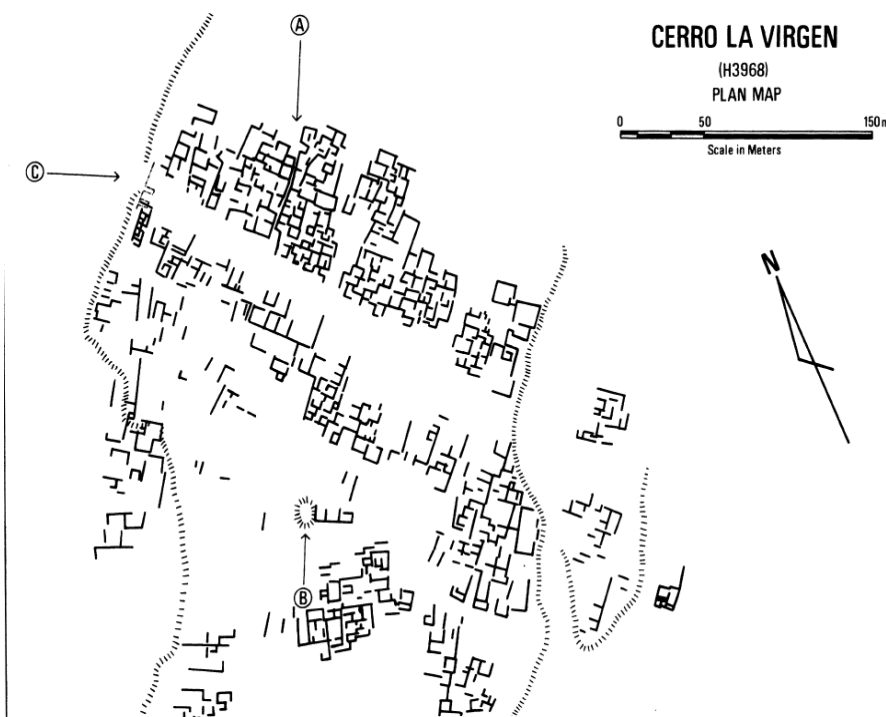

Figure 4, Cerro la Virgen

The population is estimated to have been around 1000. Rooms are marked by the presence of low stone foundations which likely supported cane or adobe walls. Many of the rooms incorporate storage pits or sunken storage jars into their floors, likely for storage of agricultural products (Keatinge: 1975).

The villagers exploited a variety of environments to meet their needs. The importance of maritime resources is indicated by the presence of fish bones, scales, net weights, net fragments, and copper fishhooks. Although no boats were found in the village, small reed boats known as *caballitos*

are known to be in use during the Late Intermediate Period and continue to be used in Modern times (Keatinge: 1975).

Evidence indicates that textile production took place in the village and that the process was entirely localized. Cotton fibers and seeds were recovered from midden deposits, as were camelid fibers, bones, and feces. Pieces of woven fabric, pieces of backstrap looms, weaving accessories including spindles and whorls, and needles were also recovered from the site (Keatinge: 1975).

Northwest of the village were extensive irrigated fields fed by a canal. Although I was unable to locate information on what exactly was grown in the fields, excavations in the middens outside the village showed that maize, beans, squash, and fruits were consumed by the population and that industrial products like aforementioned cotton and gourds were in use at the site (Keatinge: 1975). The villagers of Cerro la Virgen had a wide variety in their diet. They were exploiting the sea for fish, crustaceans, and mollusks, along with farming for maize, beans, and fruit, and raising camelids for fiber and meat (Keatinge: 1975).

Cerro la Virgen is likely representative of a typical Chimu agricultural center. In addition to agriculture, they were active in a variety of specialized crafts and were creating enough surplus that long-term storage was necessary. However, villages further from the coast are not likely to rely on maritime resources.

A structure commonly associated with remote agricultural fields is known as a 'Rural administrative center.' These structures resemble the *ciudadelas* of Chan Chan in their layout and complexity, and are focused around at least one *audiencia*. Their exact function is unknown, but they likely were places where the Chimu state could organize how it maintained control over local land, water, and labor resources. The fields immediately outside the walls of the rural administrative centers flow around the structure indicating that the structure predates field construction. Generally the rural administrative centers are associated with large inter-valley canals constructed by the Chimu indicating that they may have had a role in construction and maintenance of the canal systems

(Keatinge: 1973). Canal maintenance would have been critical to the success of the inter-valley and feeder canals. The same tectonic forces that lifted the fossil bay out of the Pacific were also raising the entire coast of the Andes, requiring the canals to be re-graded on a regular basis. The canals would also become clogged with silt when they were functioning which would mean that to maintain their function they would have to be cleaned out regularly (Ortloff, et al: 1985).

A good example of one of the rural administrative centers is found at El Milagro de San Jose in the Moche Valley. The structure is along the northern edge of a well planned irrigated field system fed by a large inter-valley canal. Inside the structure are several *audiencias*, a kitchen area, and several large empty rooms. The irrigation ditches near the structure flow around it, suggesting that the structure was in place prior to the construction of the fields (Keatinge: 1974).

A similar structure is found at the site of Quebrada de Oso in the Chicama Valley. It has several large open rooms and is focused around an *audiencia*. Like the structure at El Milagro de San Jose, it is located on the edge of a well planned irrigated field system fed by an inter-valley canal and the fields were constructed after the structure (Keatinge: 1974).

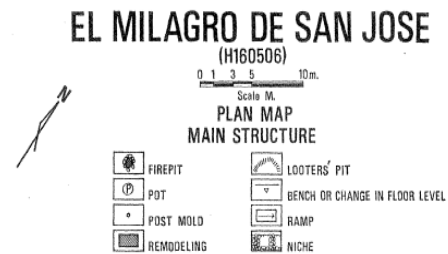
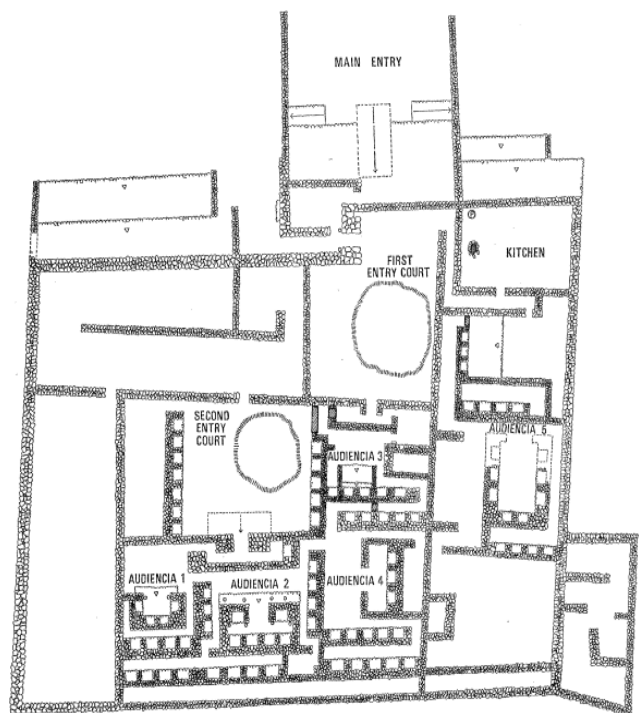

Figure 5, Rural administrative center at El Milagro de San Jose



Figure 6, Potential rural administrative centers north of the Rio Casma near Quebrada Santa Christina

Although these structures are not present at Cerro la Virgen or Quebrada Santa Christina, their absence can be explained by their proximity to large Chimu cities, destruction, or incomplete data. For example, while searching Google Maps for a satellite view of the Casma Valley raised fields I came across a group of structures closely resembling the size and

design of Chimu Rural administrative centers¹. I

could find no mention of these structures in any of

the materials I researched. It's possible these are the Rural administrative centers for the Quebrada Santa Christina site, but it is just as likely that they are completely unrelated.

	Planned Fields	Dwellings	Irrigation Canals	Storage Facilities	"Rural Administrative Center"	Long Term Occupation	Maritime Resources Exploited	Extensive Middens
Quebrada Santa Christina	x	x			?			
Cerro la Virgen	x	x	x	x		x	x	x

Table 1

Comparing Quebrada Santa Christina to Cerro la Virgen shows that it is unique among Chimu rural agricultural centers. Due to its proximity to Manchan, a rural administrative center was not needed to relay Imperial wishes. The lack of middens was due to the short-term occupation of the site. Its lack of a large canal nearby can be explained by the boggy nature of the land; it simply

¹ http://maps.google.com/maps?f=q&source=s_q&hl=en&geocode=&q=casma+valley+peru&sl=-9.4494,-78.349342&ssp=0.212004,0.264702&ie=UTF8&hq=valley+peru&hnear=Casma,+Ancash+Region,+Peru&t=h&ll=-9.435912,-78.336559&spn=0.004308,0.006866&z=18

didn't require any extra water to irrigate, though the lack of storage facilities and its short-term occupation raise questions. Why would a community be planned without any way to store its own food? Why would a fairly large field system and village be constructed and then abandoned shortly thereafter?

Initially I thought that the Inca conquest of the Chimu could explain the short-term occupation of the site. The theory being that the fields were constructed shortly before 1470, the year the Inca conquered the Chimu, and that warfare had reduced the population to a point where the new fields were no longer needed. However, this does not explain why the land was developed so late considering its proximity to Manchan. If it had been quality land for crops it would have been developed long before the 14th Century.

Further research revealed that the boggy land of the fossil bay was a poor choice for agriculture. It drained far too poorly. This could have been fixed with a massive project but it was easier to just find land more suitable for farming, such as the land further up the valley (Pozorski, et al: 1983).

There were limiting factors on which up-valley land could be used for agriculture. The land would have to be irrigated and in many places local geology would have prevented canals from being constructed. Land once made productive would eventually be rendered unsuitable for irrigation due to an inability to siphon off enough water from the rivers. This would cause the focus of agricultural production to eventually move downstream toward the coast (Ortloff, et al: 1985). This could provide an explanation as to why the fields at Quebrada Santa Christina, the associated community, and the La Muenga administrative center were created fairly recently in Andean prehistory.

An El Nino event seems to be a more likely explanation. During an El Nino the canals that fed the cultivated land could have become clogged with silt along with extreme damage to the

irrigated fields due to heavy rains. These consequences of El Nino would eventually reach a point where the fields required extensive repairs. While the repairs were going on, the fields would be unusable. The quick solution would be to drain the boggy land just outside Manchan and grow crops there until the primary fields could be repaired. In fact, ice cores and C_{14} dates show that a massive El Nino event occurred early in the 14th Century, a time period that correlates with the pottery sherds found at Quebrada Santa Christina and at La Muenga (Van Buren: 2001).

In conclusion, the available evidence suggests that the site of Quebrada Santa Christina was a temporary agricultural center, constructed after a particularly heavy El Nino event in the early 14th Century damaged up-valley agricultural centers. Had it been occupied for a long period of time we would see evidence of large-scale storage, a wider variety of economic activities taking place, exploitation of maritime resources, large midden deposits, and remodeling of the cane structures or the placement of stone foundations. Evidence thus far reveals the fields were likely abandoned shortly after repairs were completed on the primary agricultural areas further up the valley.

Bibliography

Keatinge, Richard W.

1973 Socio-Economic Organization of the Moche Valley, Peru, during the Chimu Occupation of Chan Chan *Journal of Anthropological Research* Vol. 29, No. 4, pp. 275-295

Keatinge, Richard W.

1974 Chimu Rural Administrative Centres in the Moche Valley, Peru *World Archaeology* Vol. 6, No. 1, Political Systems, pp. 66-82

Keatinge, Richard W.

1975 Urban Settlement Systems and Rural Sustaining Communities: An Example from Chan Chan's Hinterland *Journal of Field Archaeology*, Vol. 2, No. 3, pp. 215-227

Moore, Jerry D.

1988 Prehistoric Raised Field Agriculture in the Casma Valley, Peru. *Journal of Field Archaeology* Vol. 15, No. 3, pp. 265-276

Ortloff, Charles R., Robert A. Feldman, Michael E. Moseley

1985 Hydraulic Engineering and Historical Aspects of the Pre-Columbian Intravalley Canal Systems of the Moche Valley, Peru *Journal of Field Archaeology*, Vol. 12, No. 1, pp. 77-98

Pozorski, Thomas, Shelia Pozorski, Carol J. MacKey, Alexandra M. Ulana Klymyshyn

1983 Pre-Hispanic Ridged Fields of the Casma Valley, Peru. *Geographical Review* Vol. 73, No. 4, pp. 407-416

Van Buren, Mary

2001 The Archaeology of El Niño Events and Other "Natural" Disasters *Journal of Archaeological Method and Theory*, Vol. 8, No. 2, pp. 129-149

The Influence of Inca Statecraft on the Site of Huánuco Pampa

By Tori Bullock

Department of Anthropology

The Inca site of Huánuco Pampa provides us a unique insight into the Inca Empire. Because it was built entirely on a pristine site, we are able to examine Inca building techniques in a way different from sites built by other peoples and later used by the Inca, such as Pikillacta. Huánuco Pampa was an Inca provincial center located 700 kilometers northwest of the imperial Inca capital of Cusco and sits at 3,800 meters above sea level. Its construction began in the latter half of the 15th century, and the site covered 495 acres, or about 2 square kilometers (Von Hagen and Morris 1998.) The city is dominated by a large central plaza, over half a kilometer in length. The qhapaq nan, the main Inca road, passes diagonally through the site in a southeast to northwest direction towards

Quito. The capital of Cusco communicated with the city by use of the roads, and runners could be sent to Quito and back in ten to twelve days (Jenkins 2001). Huánuco Pampa did not house a large resident population. Rather, it functioned as a ritual and administrative center that had authority over as many as 30,000 people (Morris and Thompson 1985).

The Inca extracted taxes not in money but through labor. All those living in the empire were required to fulfill an annual quota of labor in service to the state, called mit'a in Quechua, which was “paid” by



Figure 1: Drawing of the site of Huánuco Pampa

the male head of household (Yarov Levine 1987). This tax could be paid in a number of ways, such as cultivating state fields or building state structures. The site of Huánuco Pampa was likely constructed by individuals who were performing their state service under the supervision of their new Inca rulers. The mere ability to command the number of people necessary to construct a city as large as Huánuco Pampa is itself an expression of power or “dynamic display” (Ogburn 2004). It was common for the Inca to send a small contingent of nobles to serve as the elite of a new area, and it was these elite who oversaw the construction of the site. According to Morris and Thompson, the site follows a generalized plan, but “most buildings in the site were simply not sufficiently important to receive strict supervision from state specialists” (Morris and Thompson 1985). This explains the influence of local building customs within the site, as well as the somewhat haphazard placement of some of the more crude round structures.

According to John Rowe, the basic unit of Inca construction is the small rectangular building (Morris and Thompson 1985.) These structures were built of fieldstone and had thatched roofs, though they have sometimes been constructed out of high quality cut stone. At Huánuco Pampa, this basic form appears repeatedly, and in a variety of orientations and sizes. All of the well-constructed structures located in the center of the site are rectangular in shape, as are many of the buildings located throughout the site. However, there are over 1,000 buildings, not including the qollqa used for storing maize, that are circular. These buildings are constructed mainly of fieldstone and are non-mortared, and display poor construction techniques compared to other buildings at the site. Most of these structures lack any type of window or the niches commonly seen in Inca dwellings. They closely resemble the residential constructions of the native people, whose ancestors built Huánuco Pampa. I believe that these structures were constructed by the workers who built Huánuco Pampa, possibly for use as temporary housing during the initial period of construction at the site. None of these structures are constructed of fine stone, such as those of the ushnu, and likely served no important ceremonial or political purpose.



Figure 2: View towards the gateways with kancha's on either side.

The dominating feature of the site is the main plaza, which measures 550 by 350 meters and has at its center a ceremonial platform known as an ushnu, where important Inca administrators officiated over rituals. Plazas and their ushnu's were key features of Inca architecture and found at various sites all over the empire (Moore 1996). The officiate of the ceremonies would have either been the Inca "governor" of this province, or, in very rare cases, the Inca ruler himself. Inca rulers were known for making occasional tours of their territories, a demonstration of the concern that the ruler showed for his people. The ushnu is constructed of rectangular cut stones, some of the finest masonry found at the site. While the masonry found at Huánuco Pampa is without a doubt extremely fine, it is not on par with the masonry found in the Inca capital of Cusco. Masonry in Cusco is cut to fit the surrounding stones. It is said that Inca masonry was so fine that not even a razor could fit between the joints in the stones. It is not surprising that the finest stonework was

reserved for buildings and structures of importance. It would ensure that features such as the ushnu and the northern compound, both integral to state functions at the site, would be comprised of the most elaborate masonry. The difference between the state buildings and those of the common people, such as the standard rectangular residential unit, reinforces the idea of the Inca state as a powerful and rich entity.



Figure 3: Ushnu during initial excavations by John Murra.

Other examples of similarly elaborate masonry are seen in the gateways that link the central plaza and ushnu to two smaller plazas, which in turn lead to a compound of buildings, platforms, and artificial pools which utilize the same fine cut stone. The gateways are constructed out of trapezoidal stones, aligned in such a way that a part of the ushnu is visible through them, closely mimicking the equinox sunrise. Feline figures nearly identical to those seen on the ushnu are also present on the gateways. The gateways are similar to those that guard Inca palaces, such as the palace at Cusco (Morris 1998). Large cooking facilities were found in the area near this architectural compound, providing further evidence for large-scale feasting activities, which took place both in and around these structures as well as in the buildings surrounding the main plaza.

Opening and flanking the plaza and ushnu are a series of buildings. These buildings are long, rectangular structures, each with several doorways. Archaeological evidence found within these structures indicate that they were used for feasting rather than for permanent residence. To the east

of the plaza is a series of interconnected architectural compounds linked by the aforementioned gateways. The two largest of these structures are called kallankas, and while excavations revealed little evidence of their function, as they were used as stables during the Colonial Period, which likely destroyed much of the archaeological evidence within them. It is thought that kallankas were used for feasting as well as for temporary housing of people present for rituals. This area is believed by Morris to be the administrative center of the site (Morris 1998).

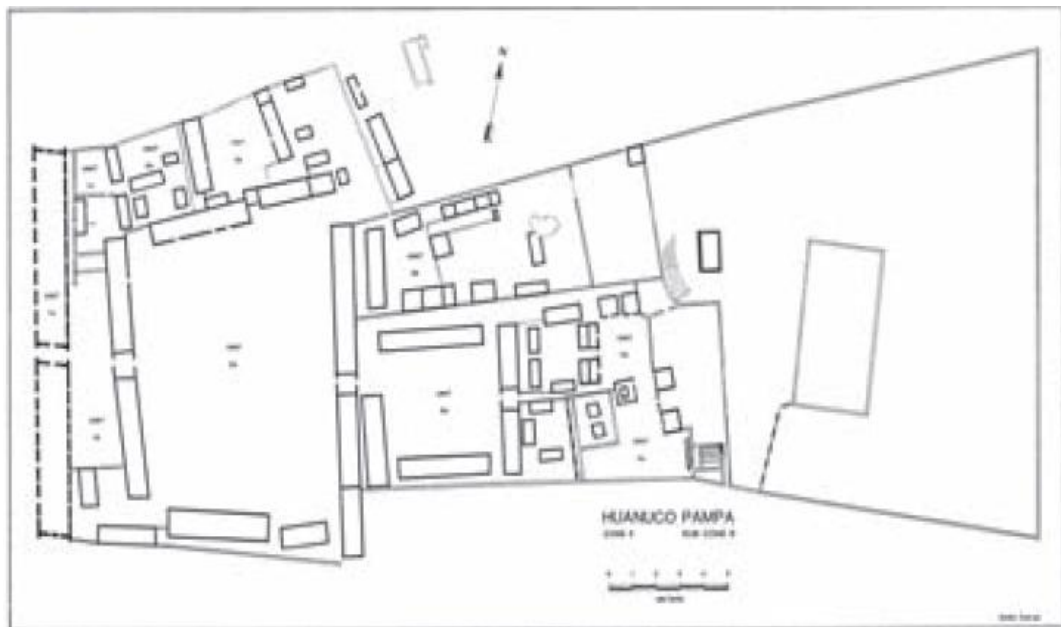

Figure 4: Zone IIB, featuring

At the north end of the site is the most regular and planned architecture at the site, a compound consisting of 50 structures enclosed by a wall. Access to this space was tightly controlled, with the only entrance through a narrow door in the southern edge of the compound. Buildings within this compound, excepting those nearest the sole entrance, are relatively uniform in size, with an average length of 18.2 meters. Archaeological evidence indicates that these structures served as both residences and workshops, and the greater density of refuse in this area of the site as compared to others suggests permanent rather than occasional residence. This area of the city was home to the *aqlla*, or cloistered women, who produced both fine woven textiles and *chicha*, or maize beer. The

importance of these two products to Inca statecraft cannot be underestimated. John Murra has detailed the importance of cloth to Andean societies, where it was exchanged and gifted during many different important life events, as well as rewarded for state service (Murra 1962.) Textiles were also used to create cohesion within the empire. Each individual city had a particular textile motif associated with it. These motifs would be woven into cloth and then worn by the citizens to identify their place of origin. The Inca ruler wore a tunic with the motifs of each city within the empire woven into it. This allowed the Inca ruler to identify with his subjects literally, and gave the ruled visual proof of their inclusion in the Inca Empire.

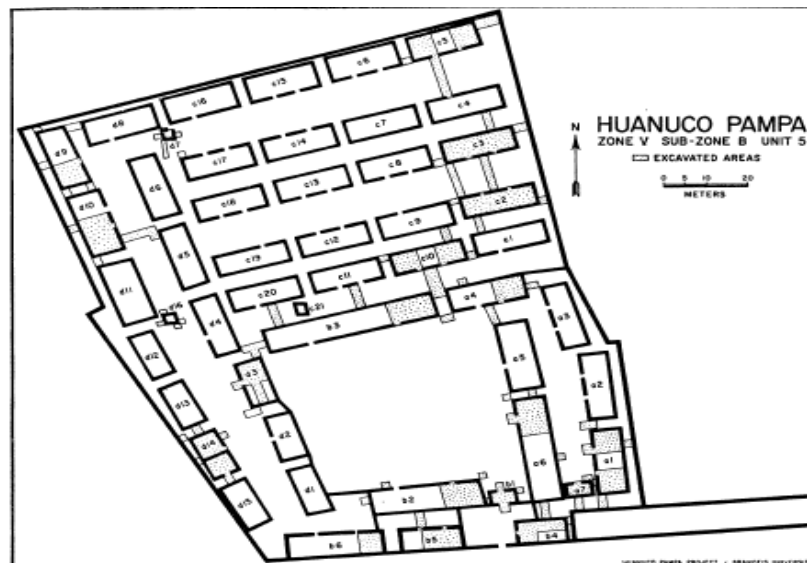

Figure 5: The Northern Compound.

Chicha was integral to feasting activities, and due to its inability to be stored, it had to be made on demand. A staple throughout the South America, chicha is a beer made of fermented maize, and is still drunk today. Enormous quantities were consumed during feasts and rituals though it was also an everyday staple. Morris and Thompson recovered artifacts relating to the brewing of chicha such as vessels associated with the storage of chicha. It was of central importance to the “corvee” or mit’a labor system employed by the Inca, with it being provided in great quantities to workers serving their state required labor service (Moore 1989). The ability to produce chicha on

such a large scale was itself an expression of the power of the empire, as it was the Inca who provided the ingredients to make chicha as well as the aqlla to make it (Moore 1989).

Located in the southern area of the site is a large and finely built kancha. The walled compound encloses 18 rectangular buildings, all but 3 of them with a length of 15 meters or greater, larger than the surrounding buildings. Based on the standardized size and construction of this compound, Morris and Thompson conclude that these structures were built by one closely supervised work crew, similar to those who would have constructed other important structures such as the northern compound or the ushnu (Morris and Thompson 1985.) This architectural form is uncommon at Huánuco Pampa though it appears quite regularly at other sites, suggesting that this area was used to house important state officials. The idiosyncrasy of the kancha at the site can be explained by lack of a large resident population at the site. The majority of the housing at the site was standardized and meant only to be used on a temporary basis by those providing their mit'a service to the state. These temporary residents stayed in the rectangular housing structures that litter the site, and because of the itinerant nature of their occupation, they did not require the space that a kancha provides.

On a hill to the south of the main site are the storage buildings or qollqas. There are 497 of these structures, as well as 30 other structures which seem to have served an administrative and supervisory purpose. Several of these structures appear to be small temples or at least have religious associations, suggesting that the Inca religious institution, the Temple of the Sun, had control over its own resources. They are arranged in long rows, and came in two forms: circular and rectangular. The circular qollqas have windows that face uphill while the rectangular ones are either single or doubled roomed. At maximum capacity, the circular storage rooms had an internal size of 14,000 m², and the rectangular nearly 23,000 m². The qollqas featured ventilated floors, which served to create an ideal temperature at which to store foodstuffs. Maize storage was limited to the circular qollqas and tuber and root vegetables to the rectangular. It should be noted that this placement

mimics the verticality of Andean agriculture as these crops are stored at positions that are reminiscent of their place of growth, with maize being stored at lower elevations than tubers.



Figure 6: Example of Circular Qollqa.

According to Morris and Thompson, the purpose and need for such extensive storage facilities was twofold: to provide the city of Huánuco Pampa with a steady supply of food, and to display the power of the Inca ruler. Due to the poor farmland in the area immediately surrounding Huánuco Pampa, it was essential to store food that was brought in from labor tax for use in the city. This food would be used to feed both the resident population as well as the temporary population of the city, who would be present for rituals or to fulfill their required labor tax within the city. The storehouses also serve as a reminder to those who see them of the power of the Inca ruler, and are visible from the north road up to 30km away. They demonstrate symbolically the Inca ruler's ability to commission the building of numerous storehouses and produced the goods to necessitate the quantity of these facilities.



Figure 7: Huánuco Pampa, view toward storehouses.

At the beginning of my research into this topic, I theorized that Huánuco Pampa was a “copy” of the Inca capital of Cusco (Christie 2007). Further research has, however, proved me wrong. While there are architectural elements lifted from Cusco, they are not copied in the sense in which I implied. Rather, elements such as the masonry seen in the ushnu were used to create a connection to Cusco, and establish a standardized state identity. As an administrative center, it was the duty of the Inca officials at Huánuco Pampa to collect the taxes due to the empire as well as to serve as a religious center. In my initial assessment of the site, I underestimated the complexities of the relationships between Huánuco Pampa and the state, as well its relationship with the local people it administered. I also suggested as a possible outcome of my research that the influence of the local population on the site would be greater than I expected. This was revealed to be true through research, particularly after discovering the number of constructions at the site which did not conform to standard Inca building forms, notably the small circular structures.

In order to fully understand the complex relationships of Huánuco Pampa, further excavations are needed. In this paper, I have demonstrated the role that the imperial Inca statecraft played in influencing the architecture at the site of Huánuco Pampa. Using standardized architecture

mimicking the capital of Cusco, the Inca sought to establish both a link to the navel of the universe as well as to impose a state identity. Rituals and feasting took place in and around the central plaza, with the purpose of creating a link between the local populace and their Inca rulers. The northern sector of the city housed a resident population of specialists who created goods integral to the Inca economy as well as its socio-political organization.

Bibliography

Christie, Jessica Joyce.

2007 Did the Inka Copy Cusco? An Answer derived from an Architectural-Sculptural Model. *The Journal of Latin American and Caribbean Archaeology* 12(1): 164-199.

Jenkins, David.

2001 A Network Analysis of Inca Roads, Administrative Centers, and Storage Facilities. *Ethnohistory* 48(4): 655-687.

Moore, Jerry D.

1996 The Archaeology of Plazas and the Proxemics of Ritual: Three Andean Traditions. *American Anthropologist* 98(4): 389-802.

Moore, Jerry D.

1989 Pre-Hispanic Beer in Coastal Peru: Technology and Social Context of Prehistoric Production. *American Anthropologist* 91(3): 682-695.

Morris, Craig.

1998 Enclosures of Power: The Multiple Spaces of Inca Administrative Palaces. Paper presented at Symposium at Dumbarton Oaks, Washington, D.C. October 11th and 12th.

Morris, Craig and Thompson, Donald E.

1985 Huánuco Pampa: An Inca City and its Hinterland.

Murra, John V.

1962 Cloth and its Functions in the Inca State. *American Anthropologist* 64(4): 710-728.

Ogburn, Dennis

2004 Dynamic Display, Propaganda, and the Reinforcement of Provincial Power in the Inca Empire. Special Issue: "Foundations of Power in the Pre-Hispanic Andes" *Archaeological Papers of the American Anthropological Association* 14(1): 225-239.

Von Hagen, Adriana, and Morris, Craig.

1998 The Cities of the Ancient Andes.

Yarov Levine, Terry

1987 Inca Labor Service at the Regional Level: The Functional Reality. *Ethnohistory* 34(1): 14-46.
